

M4 Macros for Electric Circuit Diagrams in L^AT_EX Documents

Dwight Aplevich

Contents, Version 9.7	
1 Introduction	1
2 Using the macros	2
2.1 Quick start	2
2.1.1 Using m4	3
2.1.2 Processing with dpic and PSTricks or Tikz PGF	3
2.1.3 Processing with gpic	3
2.1.4 Simplifications	4
2.2 Including the libraries	5
3 Pic essentials	6
3.1 Manuals	6
3.2 The linear objects: <code>line</code> , <code>arrow</code> , <code>spline</code> , <code>arc</code>	6
3.3 Positions	7
3.4 The planar objects: <code>box</code> , <code>circle</code> , <code>ellipse</code> , and <code>text</code>	7
3.5 Compound objects	8
3.6 Other language facilities	8
4 Two-terminal circuit elements	9
4.1 Circuit and element basics	9
4.2 The two-terminal elements	10
4.3 Branch-current arrows	14
4.4 Labels	15
5 Placing two-terminal elements	16
5.1 Series and parallel circuits	17
6 Composite circuit elements	18
6.1 Semiconductors	25
7 Corners	28
8 Looping	29
9 Logic gates	29
10 Integrated circuits	33
11 Element and diagram scaling	33
11.1 Circuit scaling	34
11.2 Pic scaling	34
12 Writing macros	35
12.1 Macro arguments	38
13 Interaction with L^AT_EX	39
14 PSTricks and other tricks	41
14.1 Tikz with pic	42
15 Web documents, pdf, and alternative output formats	42
16 Developer's notes	43
17 Bugs	44
18 List of macros	48
References	70

1 Introduction

It appears that people who are unable to execute pretty pictures with pen and paper find it gratifying to try with a computer [10].

This manual¹ describes a method for drawing electric circuits and other diagrams in L^AT_EX and web documents. The diagrams are defined in the simple pic drawing language [8] augmented with m4 macros [9], and are processed by m4 and a pic processor to convert them to Tikz PGF, PSTricks, other L^AT_EX-compatible code, or SVG. In its basic form, the method has the advantages and disadvantages of T_EX itself, since it is macro-based and non-WYSIWYG, with ordinary text input. The book from which the above quotation is taken correctly points out that the payoff can be in quality of diagrams at the price of the time spent in learning how to draw them.

A collection of basic components, most based on IEC and IEEE standards [6, 7], and conventions for their internal structure are described. Macros such as these are only a starting point, since it is often convenient to customize elements or to package combinations of them for particular drawings.

¹This document is best displayed with a reader that shows bookmarks.

2 Using the macros

This section describes the basic process of adding circuit diagrams to L^AT_EX documents to produce postscript or pdf files. On some operating systems, project management software with graphical interfaces can automate the process, but the steps can also be performed by a script, makefile, or by hand for simple documents as described in [Section 2.1](#).

The diagram source file is preprocessed as illustrated in [Figure 1](#). A configuration file is read by m4, followed by the diagram source. The result is passed through a pic interpreter to produce .tex output that can be inserted into a .tex document using the `\input` command.

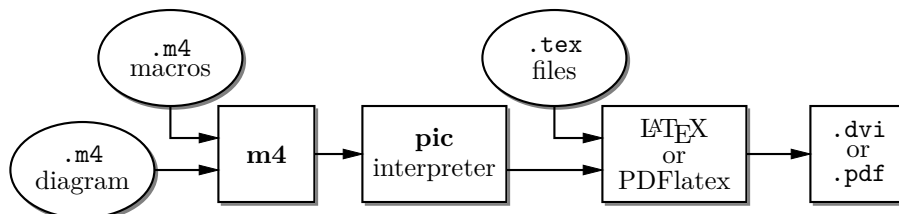

Figure 1: Inclusion of figures and macros in the L^AT_EX document.

The interpreter output contains T_ikz PGF [\[16\]](#) commands, P_STricks [\[17\]](#) commands, basic L^AT_EX graphics, tpic specials, or other formats, depending on the chosen options. These variations are described in [Section 15](#).

There are two principal choices of pic interpreter. One is dpic, described later in this document. A partial alternative is GNU gpic -t (sometimes simply named pic) [\[11\]](#) together with a printer driver that understands tpic specials, typically dvips [\[14\]](#). The dpic processor extends the pic language in small but important ways; consequently, some of the macros and examples in this distribution work fully only with dpic. Pic processors contain basic macro facilities, so some of the concepts applied here do not require m4.

2.1 Quick start

Read this section to understand basic usage of m4 and macros. The contents of file `quick.m4` and resulting diagram are shown in [Figure 2](#) to illustrate the language and the production of basic labeled circuits.

```
.PS                                # Pic input begins with .PS
cct_init                            # Read in macro definitions and set defaults
elen = 0.75                          # Variables are allowed; default units are inches
Origin: Here                         # Position names are capitalized
  source(up_ elen); llabel(-,v_s,+)
  resistor(right_ elen); rlabel(,R,)
  dot
  {                                  # Save the current position and direction
    capacitor(down_ to (Here,Origin))  #(Here,Origin) = (Here.x,Origin.y)
    rlabel(+,v,-); llabel(,C,)
    dot
  }                                  # Restore position and direction
  line right_ elen*2/3
  inductor(down_ Here.y-Origin.y); rlabel(,L,); b_current(i)
  line to Origin
.PE                                  # Pic input ends
```

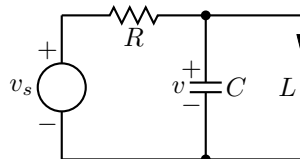

Figure 2: The file `quick.m4` and resulting diagram. There are several ways of drawing the same picture; for example, nodes (such as `Origin`) can be defined and circuit branches drawn between them; or absolute coordinates can be used (e.g., `source(up_ from (0,0) to (0,0.75))`). Element sizes and styles can be varied as described in later sections.

2.1.1 Using m4

The command

```
m4 filename ...
```

causes m4 to search for the named files in the current directory and directories specified by environmental variable M4PATH. Set M4PATH to the full name (i.e., the path) of the directory containing libcct.m4 and the other circuit library .m4 files; otherwise invoke m4 as m4 -I installdir where installdir is the path to the directory containing the library files. Now there are at least two basic possibilities as follows, but be sure to read [Section 2.1.4](#) for simplified use.

2.1.2 Processing with dpic and PSTricks or Tikz PGF

If you are using dpic with PSTricks, put `\usepackage{pstricks}` in the main L^AT_EX source file header and type the following commands or put them into a script:

```
m4 pstricks.m4 quick.m4 > quick.pic  
dpic -p quick.pic > quick.tex
```

To produce Tikz PGF code, the L^AT_EX header should contain `\usepackage{tikz}`. The commands are modified to read pgf.m4 and invoke the -g option of dpic as follows:

```
m4 pgf.m4 quick.m4 > quick.pic  
dpic -g quick.pic > quick.tex
```

A configuration file (pstricks.m4 and pgf.m4 in the above examples) is *always* the first file to be given to m4. Put the following or its equivalent in the document body:

```
\begin{figure}[ht]  
  \centering  
  \input quick  
  \caption{Customized caption for the figure.}  
  \label{Symbolic_label}  
\end{figure}
```

Then for PSTricks, the commands “`latex file; dvips file`” produce `file.ps`, which can be printed or viewed using `gsview`, for example. For Tikz PGF, Invoking PDF_latex on the source produces `.pdf` output directly. The essential line is `\input quick` whether or not the figure environment is used.

The effect of the m4 command above is shown in [Figure 3](#). Configuration files pstricks.m4 or pgf.m4 cause library libgen.m4 to be read, thereby defining the macro `cct_init`. The diagram source file is then read and the circuit-element macros in libcct.m4 are defined during expansion of `cct_init`.

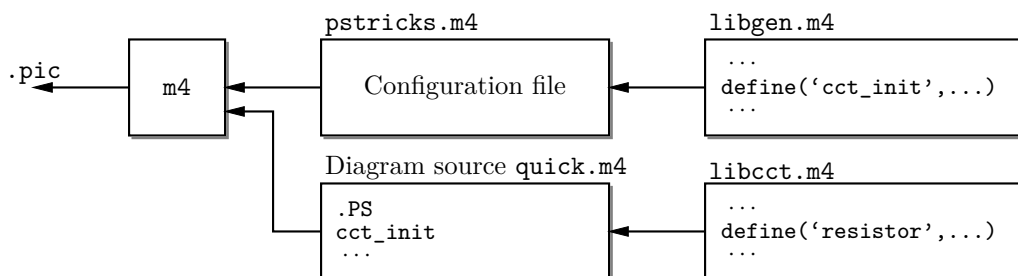

Figure 3: The command `m4 pstricks.m4 quick.m4 > quick.pic`.

2.1.3 Processing with gpic

If your printer driver understands tpic specials and you are using gpic (on some systems the gpic command is pic), the commands are

```
m4 gpic.m4 quick.m4 > quick.pic
gpic -t quick.pic > quick.tex
```

and the figure inclusion statements are as shown:

```
\begin{figure}[ht]
  \input quick
  \centerline{\box\graph}
  \caption{Customized caption for the figure.}
  \label{Symbolic_label}
\end{figure}
```

2.1.4 Simplifications

M4 must read a configuration file before any other files, either before reading the diagram source file or at the beginning of it. There are several ways to control the process, as follows:

1. The macros can be processed by L^AT_EX-specific project software and by graphic applications such as Pycircuit [12]. Alternatively when many files are to be processed, a facility such as Unix “make,” which is also available in PC and Mac versions, can be employed to automate the required commands. On systems without such facilities, a scripting language can be used.

2. The m4 commands illustrated above can be shortened to

```
m4 quick.m4 > quick.pic
```

by inserting `include(pstricks.m4)` (assuming PSTricks processing) *immediately* after the `.PS` line, the effect of which is shown in Figure 4. However, if you then want to use Tikz PGF, the line must be changed to `include(pgf.m4)`.

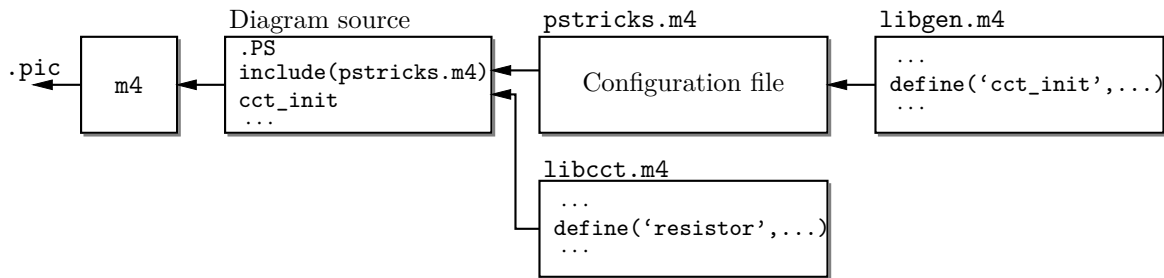

Figure 4: The command `m4 quick.m4 > quick.pic`, with `include(pstricks.m4)` preceding `cct_init`.

3. In the absence of a need to examine the file `quick.pic`, the commands for producing the `.tex` file can be reduced (provided the above inclusions have been made) to

```
m4 quick.m4 | dpic -p > quick.tex
```

4. You can put several diagrams into a single source file. Make each diagram the body of a L^AT_EX macro, as shown:

```
\newcommand{\diaA}{%
  .PS
  drawing commands
  .PE
\box\graph }% \box\graph not required for dpic
\newcommand{\diaB}{%
  .PS
  drawing commands
  .PE
\box\graph }% \box\graph not required for dpic
```

Produce a `.tex` file as usual, insert the `.tex` into the L^AT_EX source, and invoke the macros `\diaA` and `\diaB` at the appropriate places.

- In some circumstances, it may be desirable to invoke `m4` and `dpic` automatically from the document. Define a macro `\mtotex` as shown in the following example:

```

\documentclass{article}
\usepackage{tikz}
\newcommand\mtotex[2]{\immediate\write18{m4 #2.m4 | dpic -#1 > #2.tex}}%
\begin{document}
\mtotex{g}{FileA} % Generate FileA.tex
\input{FileA.tex} \par
\mtotex{g}{FileB} % Generate FileB.tex
\input{FileB.tex}
\end{document}

```

The first argument of `\mtotex` is a `p` for `pstricks` or `g` for `pgf`. Sources `FileA.m4` and `FileB.m4` must contain any required `include` statements, and the main document should be processed using the `latex` or `pdflatex` option `--shell-escape`. If the `M4PATH` environment variable is not set then insert `-I installdir` after `m4` in the command definition, where `installdir` is the absolute path to the installation directory. This method processes the picture source each time \LaTeX is run, so for large documents containing many diagrams, the `\mtotex` lines could be commented out after debugging the corresponding graphic. A derivative of this method that allows the insertion of `pic` code into a `Tikz` picture is described in [Section 14.1](#).

- It might be convenient for the source of small diagrams to be part of the document source text. The `filecontents` environment of current \LaTeX allows this; older versions can employ a now-obsolete package `filecontents.sty`. The following example for processing by `pdflatex --shell-escape` first writes the `m4` source to file `sample.m4`, invokes `\mtotex` on it, and reads in the result:

```

\begin{filecontents}[overwrite,noheader,nosearch]{sample.m4}
include(pgf.m4)
.PS
cct_init
drawing commands ...
.PE
\end{filecontents}
\mtotex{g}{sample}
\input{sample.tex}

```

2.2 Including the libraries

The configuration files for `dpic` are as follows, depending on the output format (see [Section 15](#)): `pstricks.m4`, `pgf.m4`, `mpic.m4`, `mpost.m4`, `postscript.m4`, `psfrag.m4`, `svg.m4`, `gpic.m4`, or `xfig.m4`. The file `psfrag.m4` simply defines the macro `psfrag_` and then reads `postscript.m4`. For `gpic`, the configuration file is `gpic.m4`. The usual case for producing circuit diagrams is to read `pstricks.m4` or `pgf.m4` first when `dpic` is the postprocessor or to set one of these as the default configuration file.

At the top of each diagram source, put one or more initialization commands; that is, `cct_init`, `log_init`, `sfg_init`, `darrow_init`, `threeD_init` or, for diagrams not requiring specialized macros, `gen_init`. As shown in [Figures 3](#) and [4](#), each initialization command reads in the appropriate macro library if it hasn't already been read; for example, `cct_init` tests whether `libcct.m4` has been read and includes it if necessary.

A few of the distributed example files contain other experimental macros that can be pasted into diagram source files; see `Flow.m4` or `Buttons.m4`, for example.

The libraries contain hints and explanations that might help in debugging or if you wish to modify any of the macros. Macros are generally named using the obvious circuit element names so that programming becomes something of an extension of the `pic` language. Some macro names

end in an underscore to reduce the chance of name clashes. These can be invoked in the diagram source but there is no long-term guarantee that their names and functionality will remain unchanged. Finally, macros intended only for internal use begin with the characters `m4`.

3 Pic essentials

Pic source is a sequence of lines in a text file. The first line of a diagram begins with `.PS` with optional following arguments, and the last line is normally `.PE`. Lines outside of these pass through the pic processor unchanged.

The visible objects can be divided conveniently into two classes, the *linear* objects `line`, `arrow`, `spline`, `arc`, and the *planar* objects `box`, `circle`, `ellipse`.

The object `move` is linear but draws nothing. A compound object, or `block`, is planar and consists of a pair of square brackets enclosing other objects, as described in [Section 3.5](#).

Objects can be placed using absolute coordinates or, as is often better, relative to other objects.

Pic allows the definition of real-valued variables, which are alphameric names beginning with lower-case letters, and computations using them. Objects or locations on the diagram can be given symbolic names beginning with an upper-case letter.

3.1 Manuals

The classic pic manual [8] is still a good introduction to pic, but a more complete manual [13] can be found in the GNU groff package, and both are available on the web [8, 13]. Reading either will give you competence with pic in an hour or two. Explicit mention of `*roff` string and font constructs in these manuals should be replaced by their equivalents in the L^AT_EX context. A man-page language summary is appended to the dpic manual [1].

A web search will yield good discussions of “little languages”; for pic in particular, see Chapter 9 of [2]. Chapter 1 of reference [4] also contains a brief discussion of this and other languages.

3.2 The linear objects: `line`, `arrow`, `spline`, `arc`

A line can be drawn as follows:

```
line from position to position
```

where *position* is defined below or

```
line direction distance
```

where *direction* is one of `up`, `down`, `left`, `right`. When used with the `m4` macros described here, it is preferable to add an underscore: `up_`, `down_`, `left_`, `right_`. The *distance* is a number or expression and the units are inches, but the assignment

```
scale = 25.4
```

has the effect of changing the units to millimetres, as described in [Section 11](#).

Lines can also be drawn to any distance in any direction. The example,

```
line up_ 3/sqrt(2) right_ 3/sqrt(2) dashed
```

draws a line 3 units long from the current location, at a 45° angle above horizontal. Lines (and other objects) can be specified as `dotted`, `dashed`, or `invisible`, as above.

The construction

```
line from A to B chop x
```

truncates the line at each end by `x` (which may be negative) or, if `x` is omitted, by the current circle radius, a convenience when `A` and `B` are circular graph nodes, for example. Otherwise

```
line from A to B chop x chop y
```

truncates the line by `x` at the start and `y` at the end.

Any of the above means of specifying line (or arrow) direction and length will be called a *linespec*.

Lines can be concatenated. For example, to draw a triangle:

```
line up_ sqrt(3) right_ 1 then down_ sqrt(3) right_ 1 then left_ 2
```

3.3 Positions

A *position* can be defined by a coordinate pair; e.g., 3,2.5, more generally using parentheses by (*expression*, *expression*), as a sum or difference; e.g., *position* + (*expression*, *expression*), or by the construction (*position*, *position*), the latter taking the *x*-coordinate from the first position and the *y*-coordinate from the second. A position can be given a symbolic name beginning with an upper-case letter, e.g. Top: (0.5,4.5). Such a definition does not affect the calculated figure boundaries. The current position Here is always defined and is equal to (0,0) at the beginning of a diagram or block. The coordinates of a position are accessible, e.g. Top.x and Top.y can be used in expressions. The center, start, and end of linear objects (and the defined points of other objects as described below) are predefined positions, as shown in the following example, which also illustrates how to refer to a previously drawn element if it has not been given a name:

```
line from last line.start to 2nd last arrow.end then to 3rd line.center
```

Objects can be named (using a name commencing with an upper-case letter), for example:

```
Bus23: line up right
```

after which, positions associated with the object can be referenced using the name; for example:

```
arc cw from Bus23.start to Bus23.end with .center at Bus23.center
```

An arc is drawn by specifying its rotation, starting point, end point, and center, but sensible defaults are assumed if any of these are omitted. Note that

```
arc cw from Bus23.start to Bus23.end
```

does *not* define the arc uniquely; there are two arcs that satisfy this specification. This distribution includes the m4 macros

```
arcr( position, radius, start radians, end radians, modifiers, ht)
```

```
arcd( position, radius, start degrees, end degrees, modifiers, ht)
```

```
arca( chord linespec, ccw|cw, radius, modifiers)
```

to draw uniquely defined arcs. If the fifth argument of `arcr` or `arcd` contains `->` or `<-` then a midpoint arrowhead of height specified by `arg6` is added. For example,

```
arcd((1,-1),,0,-90,<- outlined "red") dotted
```

draws a red dotted arc with midpoint arrowhead, centre at (1, -1), and default radius. The example

```
arca(from (1,1) to (2,2),,1,->)
```

draws an acute angled arc with arrowhead on the chord defined by the first argument.

The linear objects can be given arrowheads at the start, end, or both ends, for example:

```
line dashed <- right 0.5
```

```
arc <-> height 0.06 width 0.03 ccw from Here to Here+(0.5,0) \
```

```
with .center at Here+(0.25,0)
```

```
spline -> right 0.5 then down 0.2 left 0.3 then right 0.4
```

The arrowheads on the arc above have had their shape adjusted using the `height` and `width` parameters.

3.4 The planar objects: box, circle, ellipse, and text

Planar objects are drawn by specifying the width, height, and position, thus:

```
A: box ht 0.6 wid 0.8 at (1,1)
```

after which, in this example, the position `A.center` is defined, and can be referenced simply as `A`. The compass points `A.n`, `A.s`, `A.e`, `A.w`, `A.ne`, `A.se`, `A.sw`, `A.nw` are automatically defined, as are the dimensions `A.height` and `A.width`. Planar objects can also be placed by specifying the location of a defined point; for example, two touching circles can be drawn as shown:

```
circle radius 0.2
```

```
circle diameter (last circle.width * 1.2) with .sw at last circle.ne
```

The planar objects can be filled with gray or colour. For example, either

```
box dashed fill_(number) or box dashed outlined "color" shaded "color"
```

produces a dashed box. The first case has a gray fill determined by *number*, with 0 corresponding to black and 1 to white; the second case allows color outline and fill, the color strings depending on the postprocessor. Postprocessor-compatible RGB color strings are produced by the macro `rgbstring(red fraction, green fraction, blue fraction)`; to produce an orange fill for example:

```
... shaded rgbstring( 1, 0.645, 0)
```

Basic colours for lines and fills are provided by `gpic` and `dpic`, but more elaborate line and fill styles or other effects can be incorporated, depending on the postprocessor, using

```
command "string"
```

where *string* is one or more postprocessor command lines.

Arbitrary text strings, typically meant to be typeset by L^AT_EX, are delimited by double-quote characters and occur in two ways. The first way is illustrated by

```
"\large Resonances of $C_{20}H_{42}$" wid x ht y at position
```

which writes the typeset result, like a box, at *position* and tells `pic` its size. The default size assumed by `pic` is given by parameters `textwid` and `textht` if it is not specified as above. The exact typeset size of formatted text can be obtained as described in [Section 13](#). The second occurrence associates one or more strings with an object, e.g., the following writes two words, one above the other, at the centre of an ellipse:

```
ellipse "\bf Stop" "\bf here"
```

The C-like `pic` function `sprintf("format string", numerical arguments)` is equivalent to a string. (Its implementation passes arguments singly to the C `snprintf` function).

3.5 Compound objects

A compound object is a group of statements enclosed in square brackets. Such an object is placed by default as if it were a box, but it can also be placed by specifying the final position of a defined point. A defined point is the center or compass corner of the bounding box of the compound object or one of its internal objects. Consider the last line of the code fragment shown:

```
Ands: [ right_
      And1: AND_gate
      And2: AND_gate at And1 - (0,And1.ht*3/2)
      ...
    ] with .And2.In1 at position
```

The two gate macros evaluate to compound objects containing `Out`, `In1`, and other locations. The final positions of all objects inside the square brackets are determined in the last line by specifying the position of `In1` of gate `And2`.

3.6 Other language facilities

All objects have default sizes, directions, and other characteristics, so part of the specification of an object can sometimes be profitably omitted.

Another possibility for defining positions is

```
expression between position and position
```

which means

```
1st position + expression × (2nd position - 1st position)
```

and which can be abbreviated as

```
expression < position , position >
```

Care has to be used in processing the latter construction with `m4`, since the comma may have to be put within quotes, ‘,’ to distinguish it from the `m4` argument separator.

Positions can be calculated using expressions containing variables. The scope of a position is the current block. Thus, for example,

```
theta = atan2(B.y-A.y,B.x-A.x)
line to Here+(3*cos(theta),3*sin(theta)).
```

Expressions are the usual algebraic combinations of primary quantities: constants, environmental parameters such as `scale`, variables, horizontal or vertical coordinates of terms such as `position.x` or `position.y`, dimensions of `pic` objects, e.g. `last_circle.rad`. The elementary algebraic operators are `+`, `-`, `*`, `/`, `%`, `=`, `+=`, `-=`, `*=`, `/=`, and `%=`, similar to the C language.

The logical operators `==`, `!=`, `<=`, `>=`, `>`, and `<` apply to expressions and strings. A modest selection of numerical functions is also provided: the single-argument functions `sin`, `cos`, `log`, `exp`, `sqrt`, `int`, where `log` and `exp` are base-10, the two-argument functions `atan2`, `max`, `min`, and the random-number generator `rand()`. Other functions are also provided using macros.

A pic manual should be consulted for details, more examples, and other facilities, such as the branching facility

```
if expression then { anything } else { anything },
```

the looping facility

```
for variable = expression to expression by expression do { anything },
```

operating-system commands, pic macros, and external file inclusion.

4 Two-terminal circuit elements

There is a fundamental difference between the two-terminal elements, each of which is drawn along an invisible straight-line segment, and other elements, which are compound objects mentioned in [Section 3.5](#). The two-terminal element macros follow a set of conventions described in this section, and other elements will be described in [Section 6](#).

4.1 Circuit and element basics

A list of the library macros and their arguments is in [Section 18](#). The arguments have default values, so that only those that differ from defaults need be specified.

[Figure 5](#), which shows a resistor, also serves as an example of pic commands. The first part of the source file for this figure is on the left:

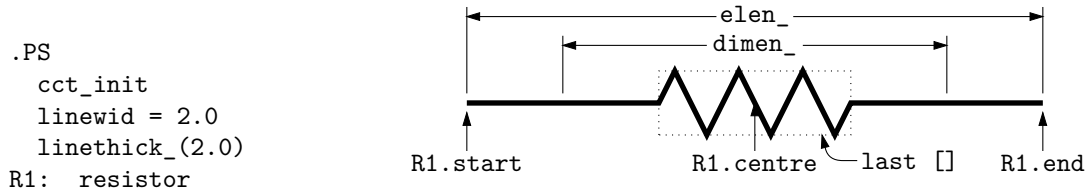

Figure 5: Resistor named R1, showing the size parameters, enclosing block, and predefined positions.

The lines of [Figure 5](#) and the remaining source lines of the file are explained below:

- The first line invokes the macro `cct_init` that loads the library `libcct.m4` and initializes local variables needed by some circuit-element macros.
- The sizes of circuit elements are proportional to the pic environmental variable `linewid`, so redefining this variable changes element sizes. The element body is drawn in proportion to `dimen_`, a macro that evaluates to `linewid` unless redefined, and the default element length is `elen_`, which evaluates to `dimen_*3/2` unless redefined. Setting `linewid` to 2.0 as in the example means that the default element length becomes 3.0 in. For resistors, the default length of the body is `dimen_/2`, and the width is `dimen_/6`. All of these values can be customized. Element scaling and the use of SI units is discussed further in [Section 11](#).
- The macro `linethick_` sets the default thickness of subsequent lines (to 2.0 pt in the example). Macro arguments are written within parentheses following the macro name, with no space between the name and the opening parenthesis. Lines can be broken before macro arguments because m4 and dpic ignore white space immediately preceding arguments. Otherwise, a long line can be continued to the next by putting a backslash as the rightmost character.
- The two-terminal element macros expand to sequences of drawing commands that begin with `'line invis linespec'`, where `linespec` is the first argument of the macro if it is non-blank, otherwise the line is drawn a distance `elen_` in the current direction, which is to the right by default. The invisible line is first drawn, then the element is drawn on top of it. The element—rather, the initial invisible line—can be given a name, R1 in the example, so that positions `R1.start`, `R1.centre`, and `R1.end` are automatically defined as shown.

- The element body is overlaid by a block, which can be used to place labels around the element. The block corresponds to an invisible rectangle with horizontal top and bottom lines, regardless of the direction in which the element is drawn. A dotted box has been drawn in the diagram to show the block boundaries.
- The last sub-element, identical to the first in two-terminal elements, is an invisible line that can be referenced later to place labels or other elements. If you create your own macros, you might choose simplicity over generality, and include only visible lines.

To produce [Figure 5](#), the following embellishments were added after the previously shown source:

```
thinlines_
box dotted wid last [] .wid ht last [] .ht at last []

move to 0.85 between last [] .sw and last [] .se
spline <- down arrowht*2 right arrowht/2 then right 0.15; "\tt last []" ljust

arrow <- down 0.3 from R1.start chop 0.05; "\tt R1.start" below
arrow <- down 0.3 from R1.end chop 0.05; "\tt R1.end" below
arrow <- down last [] .c.y-last arrow.end.y from R1.c; "\tt R1.centre" below

dimension_(from R1.start to R1.end,0.45,\tt elen\_,0.4)
dimension_(right_ dimen_ from R1.c-(dimen_/2,0),0.3,\tt dimen\_,0.5)
.PE
```

- The line thickness is set to the default thin value of 0.4pt, and the box displaying the element body block is drawn. Notice how the width and height can be specified, and the box centre positioned at the centre of the block.
- The next paragraph draws two objects, a spline with an arrowhead, and a string left justified at the end of the spline. Other string-positioning modifiers than `ljust` are `rjust`, `above`, and `below`.
- The last paragraph invokes a macro for dimensioning diagrams.

4.2 The two-terminal elements

The two-terminal elements are shown in [Figures 6 to 15](#) and part of [Figure 16](#). Several elements are included more than once to illustrate some of their arguments, which are listed in detail in [Section 18](#). [Figure 6](#) shows some resistors with typical variants.

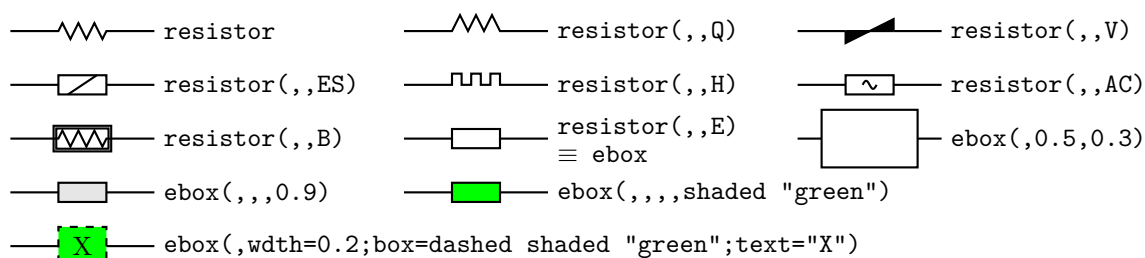

Figure 6: Resistors drawn by the macro `resistor(linespec, n|E, chars, cycle wid)`. The second argument is either an integer to specify number of cycles, the letter E, or blank. The third argument specifies the desired variant. The default `ebox` element designates a resistor.

The first macro argument specifies the invisible line segment along which the element is drawn. If the argument is blank, the element is drawn from the current position in the current drawing direction along a default length. The other arguments produce variants of the default elements.

Thus, for example,

```
resistor(up_ 1.25,7)
```

draws a resistor 1.25 units long up from the current position, with 7 vertices per side. The macro `up_` evaluates to `up` but also resets the current directional parameters to point up.

Capacitors are illustrated in Figure 7. See Section 6 for the variable macro.

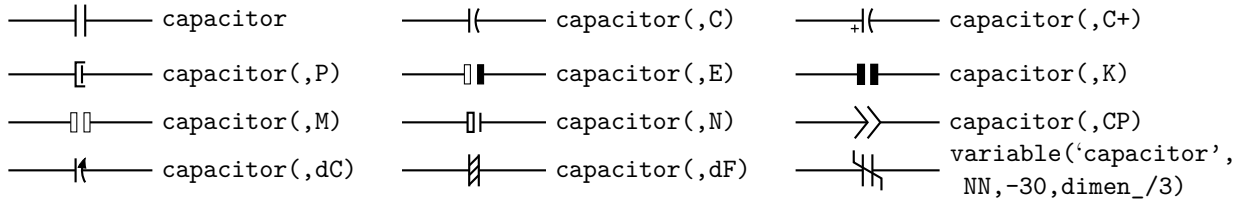

Figure 7: The capacitor(*linespec*, *chars*, [*R*], *height*, *width*) macro, and an example application of the variable macro.

Basic inductors are illustrated in Figure 8.

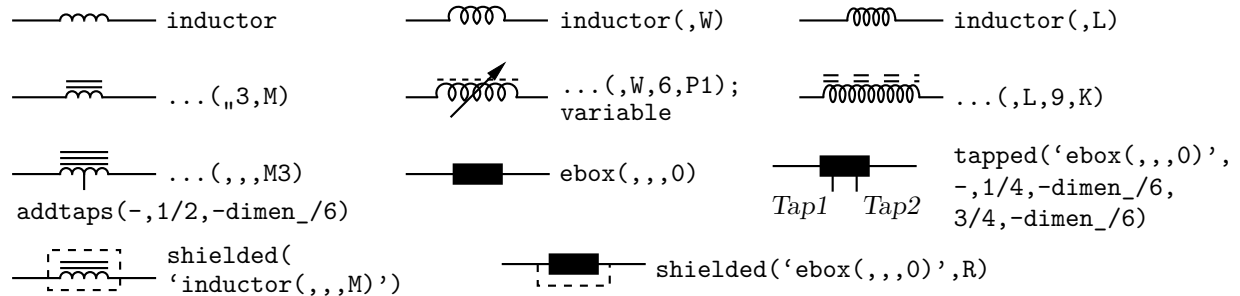

Figure 8: Basic inductors created with the inductor(*linespec*, *W*|*L*, *cycles*, *M*|*P*|*K*, *loop wid*) macro, the ebox macro for European-style inductors, and some modifications (see also Section 6). When an embellished element is repeated several times, writing a wrapper macro may be desirable.

Some more basic elements are in Figure 9, and amplifiers in Figure 10.

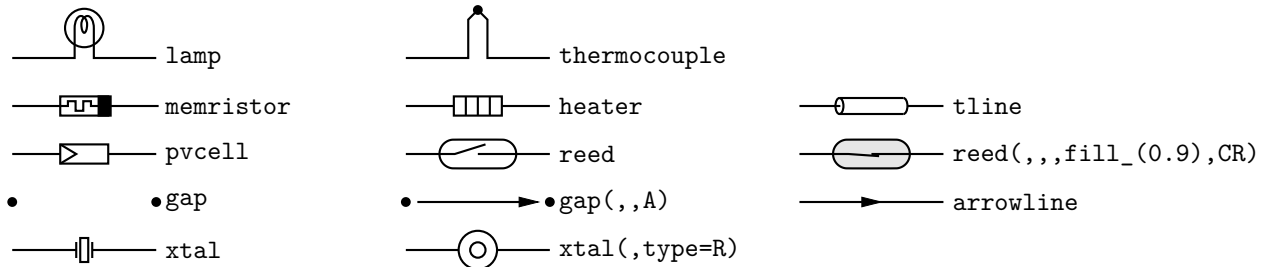

Figure 9: More two-terminal elements.

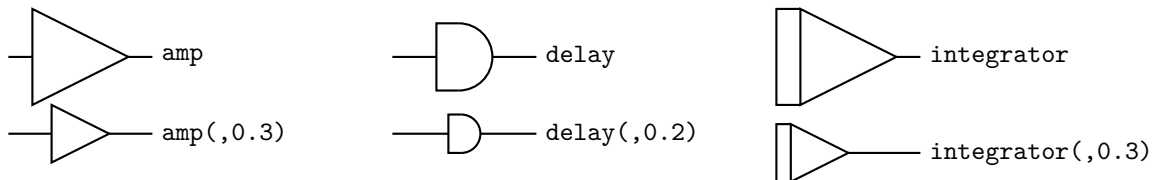

Figure 10: Amplifier, delay, and integrator.

Figure 11 shows sources, many of which contain internal symbols, and of which the AC and S options illustrate the need to draw a single cycle of a sinusoid or approximate sinusoid. As a convenience, the macro ACsymbol(*at position*, *length*, *height*, [*A*]U|D|L|R|degrees) is included as an interface to the sinusoid macro. For example to add the symbol “ \sim ” to an ebox:

```
ebox; { ACsymbol(at last [],,dimen_/8) }
```

For direct current (==), there is also DCsymbol(*at position*, *length*, *height*, U|D|L|R|degrees), and for power-system diagrams, macros Deltasymbol(*at position*, *keys*, U|D|L|R|degrees), and Ysymbol(*at position*, *keys*, U|D|L|R|degrees),

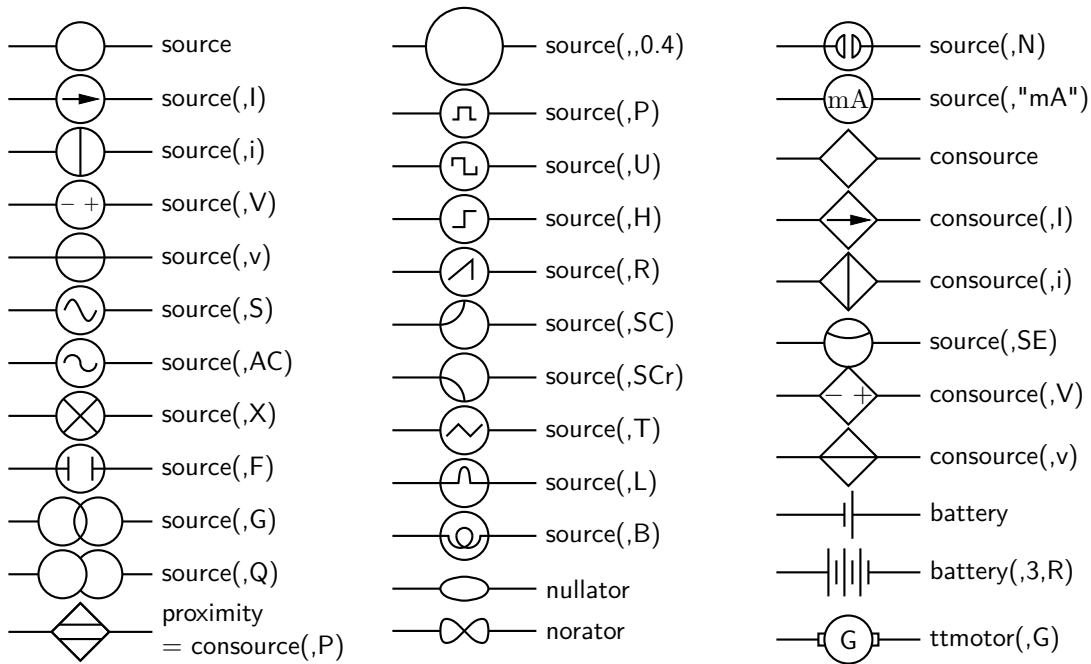

Figure 11: Sources and source-like elements.

Diodes and fuses are shown in Figures 12 and 13.

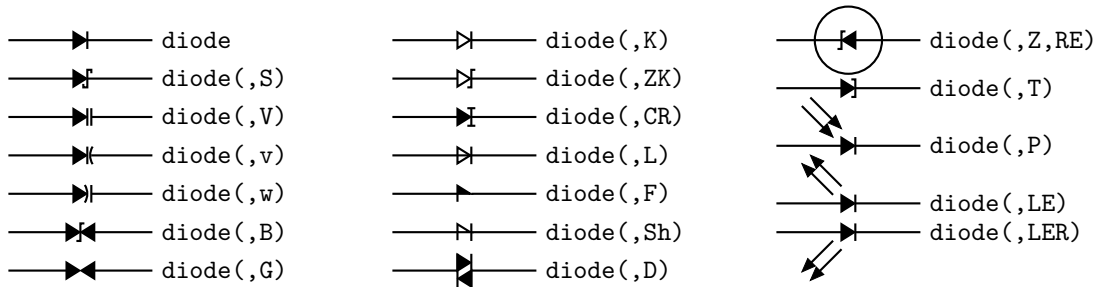

Figure 12: The macro `diode(linespec,B|CR|D|L|LE[R]|P[R]|S|T|V|v|w|Z|chars,[R][E])`. Appending K to the second argument draws an open arrowhead.

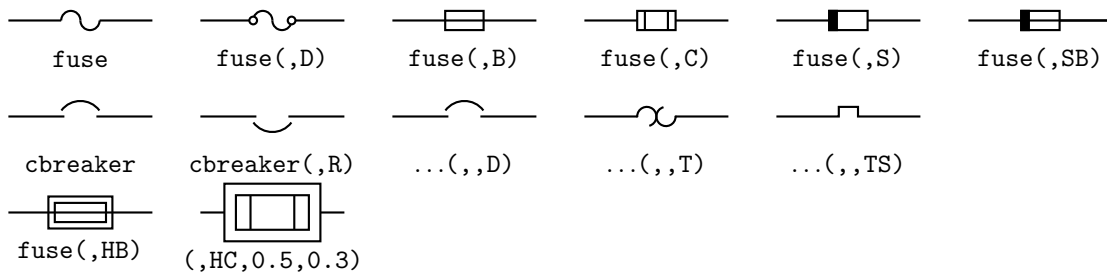

Figure 13: Variations of the macros `fuse(linespec,A|dA|B|C|D|E|S|HB|HC|SB,wid,ht)` and `cbreaker(linespec,L|R,D|T|TS)`.

Most of the two-terminal elements are oriented; that is, they have a defined direction or polarity. Several element macros include an argument that reverses polarity, but there is also a more general mechanism, as follows.

The first argument of the macro `reversed('macro name',macro arguments)`

is the name of a two-terminal element in quotes, followed by the element arguments. The element is drawn with reversed direction; thus,

```
diode(right_ 0.4); reversed('diode',right_ 0.4)
```

draws two diodes to the right, but the second one points left.

Similarly, the macro

```
resized(factor,'macro name',macro arguments)
```

can be used to resize the body of an element by temporarily multiplying the `dimen_` macro by `factor`. More general resizing should be done by redefining `dimen_` as described in [Section 11.1](#). These two macros can be nested; the following scales the above example by 1.8, for example

```
resized(1.8,'diode',right_ 0.4); resized(1.8,'reversed','diode',right_ 0.4)
```

[Figure 14](#) contains radiation-effect arrows for embellishing two-terminal and other macros. The

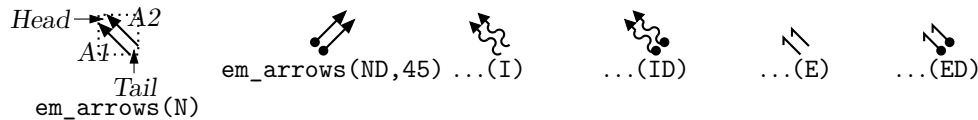

Figure 14: Radiation arrows: `em_arrows(type, angle, length)`

arrow stems are named `A1`, `A2`, and each pair is drawn in a `[]` block, with the names `Head` and `Tail` defined to aid placement near another device. The second argument specifies absolute angle in degrees (default 135 degrees). The arrows are drawn relative to the diode direction by the `LE` option in [Figure 12](#). For absolute arrow directions, one can define a wrapper (see [Section 12](#)) for the `diode` macro to draw arrows at 45 degrees, for example:

```
define('myLED','diode('$1'); em_arrows(N,45) with .Tail at last [].ne')
```

Switches with numerous controls are in [Figure 15](#).

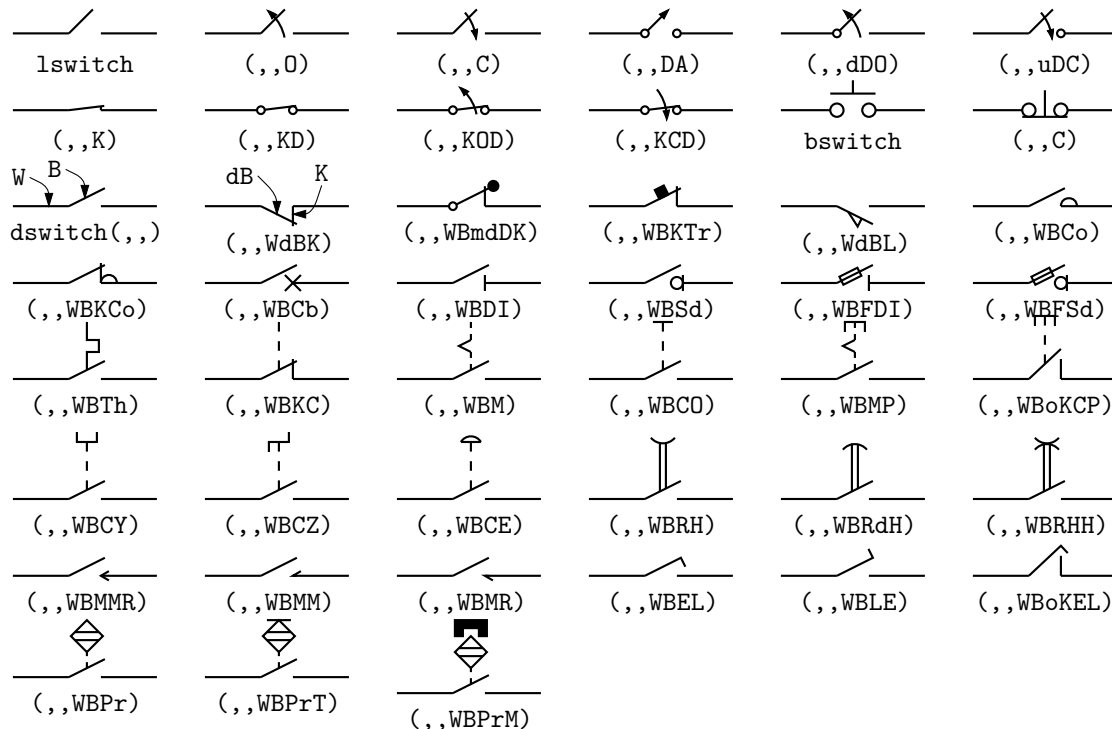

Figure 15: The `switch(linespec,L|R,chars,L|B|D)` macro is a wrapper for the macros `lswitch(linespec,[L|R],[O|C][D][K][A])`, `bswitch(linespec,[L|R],[O|C])`, and the many-optional `dswitch(linespec,R,W[ud]B[K] chars)` shown. The switch is drawn in the current drawing direction. A second-argument `R` produces a mirror image with respect to the drawing direction. The separately defined macros `Proxim` and `Magn` embellish switches in the second-last row.

Figure 16 shows a collection of surge-protection devices, or arresters, of which the E and S types may be either 2-terminal or as 3-terminal (composite) elements described in Section 6.

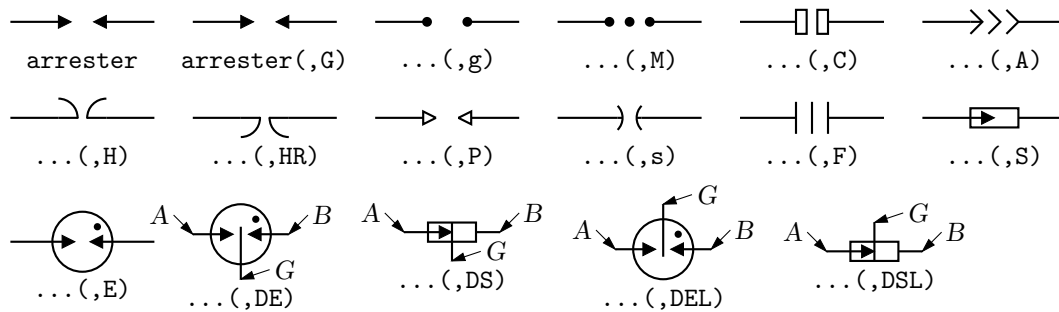

Figure 16: Variations of the `arrester(linespec, chars, wid[:arrowhead ht], ht[:arrowhead wid])` macro. Putting D in argument 2 for the S or E configuration creates a 3-terminal composite element with terminals A, B, and G.

Figure 17 shows some two-terminal elements with arrows or lines overlaid to indicate variability using the macro

```
variable('element', type, [+|-]angle, length),
```

where *type* is one of A, P, L, N, NN with C or S optionally appended to indicate continuous or stepwise variation. Alternatively, this macro can be invoked similarly to the label macros in Section 4.4 by specifying an empty first argument; thus, the following line draws the third resistor in Figure 17:

```
resistor(up_dimen_); variable(,uN)
```

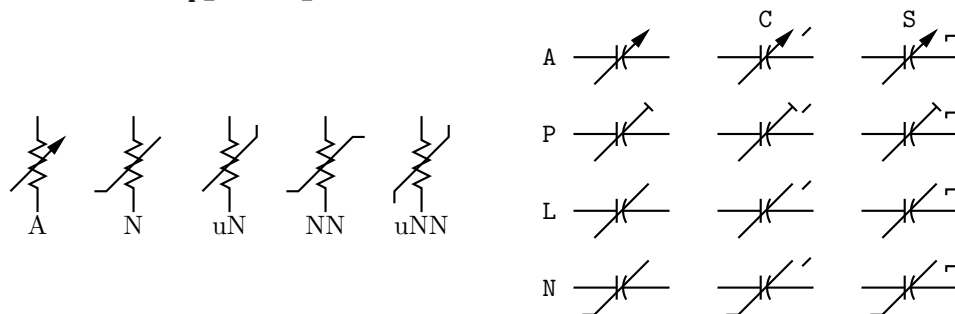

Figure 17: Illustrating `variable('element', [A|P|L|[u]N|[u]NN][C|S], [+|-]angle, length)`. For example, `variable('resistor(up_dimen_)', A)` draws the leftmost resistor shown above. The default angle is 45° , regardless of the direction of the element, but the angle preceded by a sign (+ or -) is taken to be relative to the drawing direction of the element as for the lower right capacitor in Figure 7, for example. The array on the right shows the effect of the second argument.

4.3 Branch-current arrows

Arrowheads and labels can be added to conductors using basic pic statements. For example, the following line adds a labeled arrowhead at a distance `alpha` along a horizontal line that has just been drawn. Many variations of this are possible:

```
arrow right arrowht from last line.start+(alpha,0) "$i_1$" above
```

Macros have been defined to simplify labelling two-terminal elements, as shown in Figure 18. The macro

```
b_current(label, above|below, In|O[ut], Start|E[nd], frac)
```

draws an arrow from the start of the last-drawn two-terminal element *frac* of the way toward the body.

If the fourth argument is `End`, the arrow is drawn from the end toward the body. If the third element is `Out`, the arrow is drawn outward from the body. The first argument is the desired label, of which the default position is the macro `above_`, which evaluates to `above` if the current direction

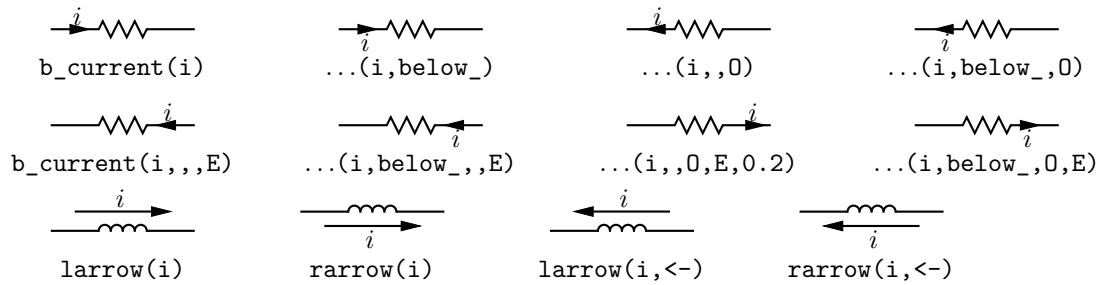

Figure 18: Illustrating `b_current`, `larrow`, and `rarrow`. The drawing direction is to the right.

is right or to `ljust`, `below`, `rjust` if the current direction is respectively down, left, up. The label is assumed to be in math mode unless it begins with `sprintf` or a double quote, in which case it is copied literally. A non-blank second argument specifies the relative position of the label with respect to the arrow, for example `below_`, which places the label below with respect to the current direction. Absolute positions, for example `below` or `ljust`, also can be specified.

For those who prefer a separate arrow to indicate the reference direction for current, the macros `larrow(label, ->|<-,dist)` and `rarrow(label, ->|<-,dist)` are provided. The label is placed outside the arrow as shown in [Figure 18](#). The first argument is assumed to be in math mode unless it begins with `sprintf` or a double quote, in which case the argument is copied literally. The third argument specifies the separation from the element.

4.4 Labels

Arbitrary labels can be positioned by any pic placement method including the representative basic examples shown:

```
"text" at position
"text" at position above
"text" wid width ht height with .sw at position
```

In addition, special macros for labeling two-terminal elements are available:

```
llabel( arg1,arg2,arg3 )
clabel( arg1,arg2,arg3 )
rlabel( arg1,arg2,arg3 )
dlabel( long,lat,arg1,arg2,arg3,[X] [A|B] [L|R] )
```

The first macro places the three arguments, which are treated as math-mode strings, on the left side of the element block *with respect to the current direction*: **up**, **down**, **left**, **right**. The second places the arguments along the centre, and the third along the right side. A simple circuit example with labels is shown in [Figure 19](#). The macro `dlabel` performs these functions for an

```
.PS
# 'Loop.m4'
cct_init
define('dimen_',0.75)
loopwid = 1; loopht = 0.75
source(up_loopht); llabel(-,v_s,+)
resistor(right_loopwid); llabel(,R,); b_current(i)
inductor(down_loopht,W); rlabel(,L,)
capacitor(left_loopwid,C); llabel(+,v_C,-); rlabel(,C,)
.PE
```

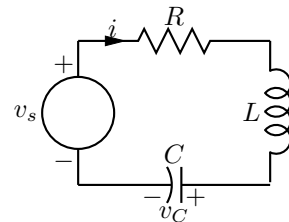

Figure 19: A loop containing labeled elements, with its source code.

obliquely drawn element, placing the three macro arguments at `vec_(-long,lat)`, `vec_(0,lat)`, and `vec_(long,lat)` respectively relative to the centre of the element. In the fourth argument, an `X` aligns the labels with respect to the line joining the two terminals rather than the element body,

and `A`, `B`, `L`, `R` use absolute `above`, `below`, `left`, or `right` alignment respectively for the labels. Labels beginning with `sprintf` or a double quote are copied literally rather than assumed to be in math mode.

5 Placing two-terminal elements

The length and position of a two-terminal element are defined by a straight-line segment, so four numbers or equivalent are required to place the element as in the following example:

```
resistor(from (1,1) to (2,1)).
```

However, `pic` has a very useful concept of the current point (explicitly named `Here`); thus,

```
resistor(to (2,1))
```

is equivalent to

```
resistor(from Here to (2,1)).
```

Any defined position can be used; for example, if `C1` and `L2` are names of previously defined two-terminal elements, then, for example, the following places the resistor:

```
resistor(from L2.end to C1.start)
```

A line segment starting at the current position can also be defined using a direction and length. To draw a resistor up `d` units from the current position, for example:

```
resistor(up_ d)
```

`Pic` stores the current drawing direction, which is unfortunately limited to `up`, `down`, `left`, `right`, for reference when necessary. The circuit macros need to know the current direction, so whenever `up`, `down`, `left`, `right` are used they should be written respectively as the macros `up_`, `down_`, `left_`, `right_` as in the above example.

To allow drawing circuit objects in other than the standard four directions, a transformation matrix is applied at the macro level to generate the required (but sometimes very elaborate) `pic` code. Potentially, the matrix elements can be used for other transformations. The macro

```
setdir_(direction, default direction)
```

is preferred when setting drawing direction. The *direction* arguments are of the form

```
R[ight] | L[eft] | U[p] | D[own] | degrees,
```

but the macros `Point_(degrees)`, `point_(radians)`, and `rpoint_(relative linespec)` are employed in many macros to re-define the entries of the matrix (named `m4a_`, `m4b_`, `m4c_`, and `m4d_`) for the required rotation. The macro `eleminit_` in the two-terminal elements invokes `rpoint_` with a specified or default *linespec* to establish element length and direction.

As shown in [Figure 20](#), “`Point_(-30); resistor`” draws a resistor along a line with slope of -30 degrees, and “`rpoint_(to Z)`” sets the current direction cosines to point from the current location to location `Z`. Macro `vec_(x,y)` evaluates to the position `(x,y)` rotated as defined by the argument of the previous `setdir_`, `Point_`, `point_` or `rpoint_` command. The principal device used to define relative locations in the circuit macros is `rvec_(x,y)`, which evaluates to position `Here + vec_(x,y)`. Thus, `line to rvec_(x,0)` draws a line of length `x` in the current direction.

[Figure 20](#) illustrates that some hand placement of labels using `dlabel` may be useful when elements are drawn obliquely. The figure also illustrates that any commas within `m4` arguments must be treated specially because the arguments are separated by commas. Argument commas are protected either by parentheses as in `inductor(from Cr to Cr+vec_(elen_,0))`, or by multiple single quotes as in ‘‘, ’’, as necessary. Commas also may be avoided by writing `0.5 between L and T` instead of `0.5<L,T>`.

```

.PS
# 'Oblique.m4'
cct_init

Ct:dot; Point_(-60); capacitor(,C); dlabel(0.12,0.12,,C_3)
Cr:dot; left_; capacitor(,C); dlabel(0.12,0.12,C_2,,)
Cl:dot; down_; capacitor(from Ct to Cl,C); dlabel(0.12,-0.12,,C_1)

T:dot(at Ct+(0,elen_))
  inductor(from T to Ct); dlabel(0.12,-0.1,,L_1)

Point_(-30); inductor(from Cr to Cr+vec_(elen_,0))
  dlabel(0,-0.1,,L_3,)

R:dot
L:dot( at Cl-(R.x-Cr.x,Cr.y-R.y) )

  inductor(from L to Cl); dlabel(0,-0.12,,L_2,)
  right_; resistor(from L to R); rlabel(R_2,)
  resistor(from T to R); dlabel(0,0.15,,R_3,) ; b_current(\;y,ljust)
  line from L to 0.2<L,T>
  source(to 0.5 between L and T); dlabel(sourcerad_+0.07,0.1,-,+,)
    dlabel(0,sourcerad_+0.07,,u,)
  resistor(to 0.8 between L and T); dlabel(0,0.15,,R_1,)
  line to T
.PE

```

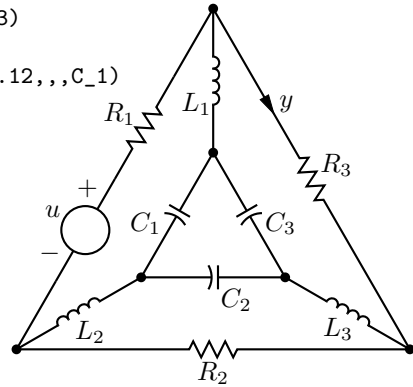

Figure 20: Illustrating elements drawn at oblique angles.

5.1 Series and parallel circuits

To draw elements in series, each element can be placed by specifying its line segment as described previously, but the pic language makes some geometries particularly simple. Thus,

```

setdir_(Right)
resistor; llabel(R); capacitor; llabel(C); inductor; llabel(L)

```

draws three elements in series as shown in the top line of Figure 21. However, the default length

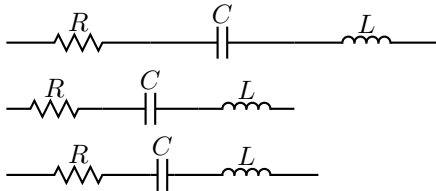

Figure 21: Three ways of drawing basic elements in series.

`elen_` appears too long for some diagrams. It can be redefined temporarily (to `dimen_`, say), by enclosing the above line in the pair

```

pushdef('elen_',dimen_) resistor... popdef('elen_')

```

with the result shown in the middle row of the figure.

Alternatively, the length of each element can be tuned individually; for example, the capacitor in the above example can be shortened as shown, producing the bottom line of Figure 21:

```

resistor; llabel(R)
capacitor(right_ dimen_/4); llabel(C)
inductor; llabel(L)

```

If a macro that takes care of common cases automatically is to be preferred, you can use the macro `series_(elementspec, elementspec, ...)`. This macro draws elements of length `dimen_` from the current position in the current drawing direction, enclosed in a `[]` block. The internal names `Start`, `End`, and `C` (for centre) are defined, along with any element labels. An `elementspec` is of the form `[Label:] element; [attributes]`, where an attribute is zero or more of `llabel(...)`, `rlabel(...)`, or `b_current(...)`.

Drawing elements in parallel requires a little more effort but, for example, three elements can be drawn in parallel using the code snippet shown, producing the left circuit in [Figure 22](#):

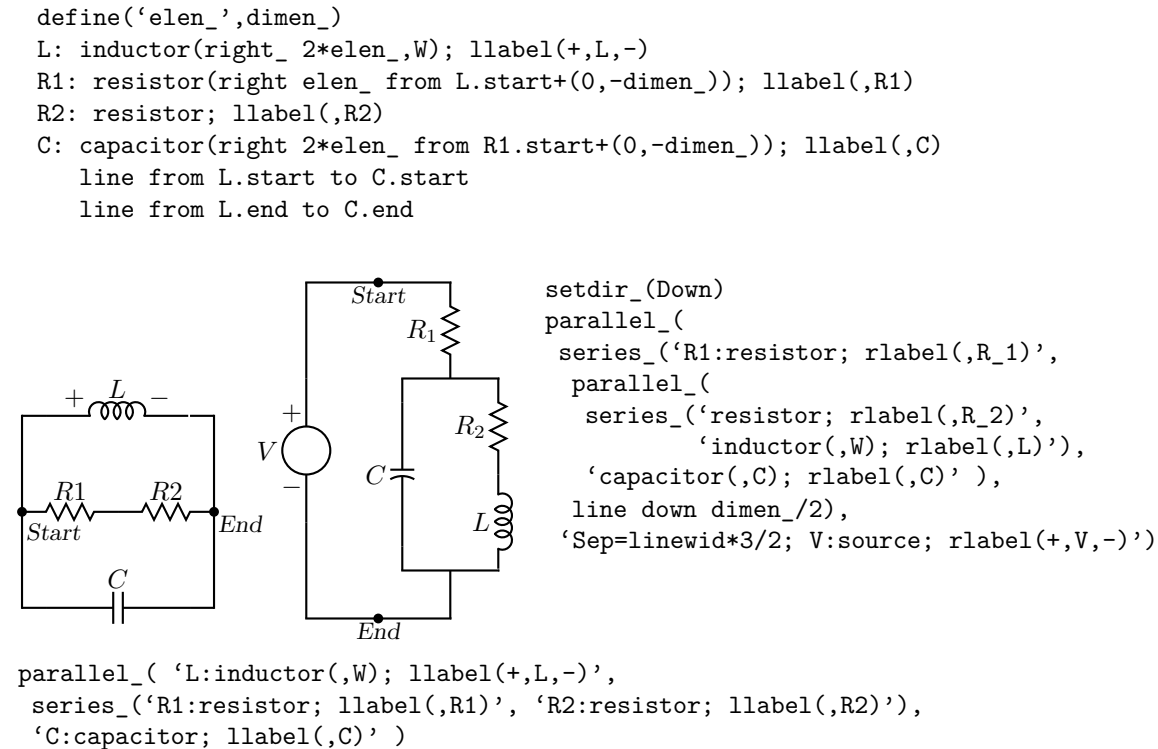

Figure 22: Illustrating the macros `parallel_` and `series_`, with `Start` and `End` points marked.

A macro that produces the same effect automatically is

```
parallel_('elementspec', 'elementspec', ...)
```

The arguments *must be quoted* to delay expansion, unless an argument is a nested `parallel_` or `series_` macro, in which case it is not quoted. The elements are drawn in a [] block with defined points `Start`, `End`, and `C`. An *elementspec* is of the form

```
[Sep=val;][Label:] element; [attributes]
```

where an *attribute* is of the form

```
[llabel(...);] | [rlabel(...)] | [b_current(...);]
```

Putting `Sep=val;` in the first branch sets the default separation of all branches to `val`; in a later element, `Sep=val;` applies only to that branch. An element may have normal arguments but should not change the drawing direction.

6 Composite circuit elements

Many basic elements are not two-terminal. These elements are usually enclosed in a [] pic block, and contain named interior locations and components. The block must be placed by using its compass corners, thus: *element with corner at position* or, when the block contains a predefined location, thus: *element with location at position*. A few macros are positioned with the first argument; the `ground` macro, for example: `ground(at position)`. In some cases, an invisible line can be specified by the first argument to determine length and direction (but not position) of the block.

Nearly all elements drawn within blocks can be customized by adding an extra argument, which is executed as the last item within the block.

The macro `potentiometer` (*linespec, cycles, fractional pos, length, ...*), shown in [Figure 23](#), first draws a resistor along the specified line, then adds arrows for taps at fractional positions along the body, with default or specified length. A negative length draws the arrow from the right of the current drawing direction.

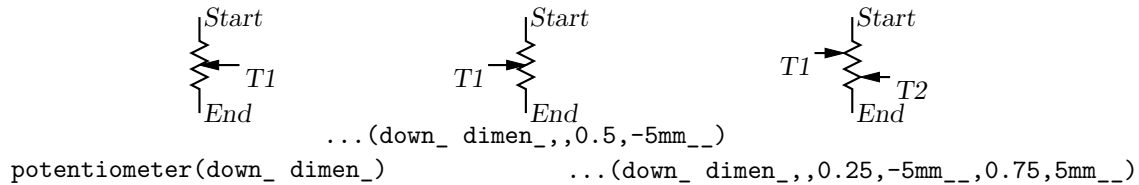

Figure 23: Default and multiple-tap potentiometer.

The macro `addtaps` (*[arrowhd | type=arrowhd;name=Name], fraction, length, fraction, length, ...*), shown in [Figure 24](#), will add taps to the immediately preceding two-terminal element. However,

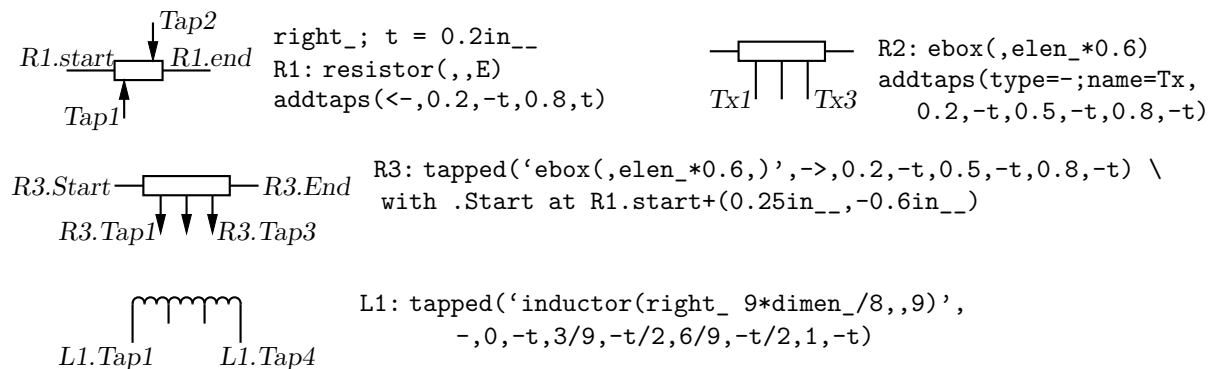

Figure 24: Macros for adding taps to two-terminal elements.

the default names `Tap1`, `Tap2` ... may not be unique in the current scope. An alternative name for the taps can be specified or, if preferable, the tapped element can be drawn in a `[]` block using the macro `tapped` (*'two-terminal element', [arrowhd | type=arrowhd;name=Name], fraction, length, fraction, length, ...*). Internal names `.Start`, `.End`, and `.C` are defined automatically, corresponding to the drawn element. These and the tap names can be used to place the block. These two macros require the two-terminal element to be drawn either up, down, to the left, or to the right; they are not designed for obliquely drawn elements.

A few composite symbols derived from two-terminal elements are shown in [Figure 25](#).

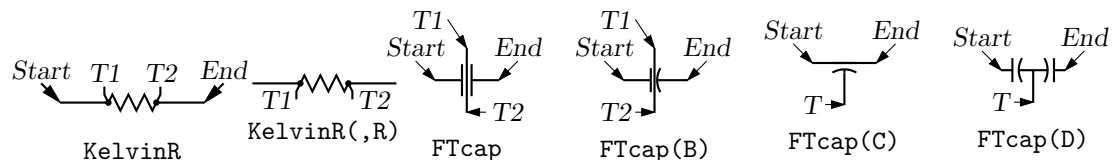

Figure 25: Composite elements `KelvinR` (*cycles, [R], cycle wid*) and `FTcap` (*chars*) .

The ground symbol is shown in [Figure 26](#). The first argument specifies position; for example, the two lines shown have identical effect:

```
move to (1.5,2); ground
ground(at (1.5,2))
```

The second argument truncates the stem, and the third defines the symbol type. The fourth argument specifies the angle at which the symbol is drawn, with D (down) the default. This macro is one of several in which a temporary drawing direction is set using the `setdir` (`U|D|L|R|degrees, default R|L|U|D|degrees`) macro and reset at the end using `resetdir` .

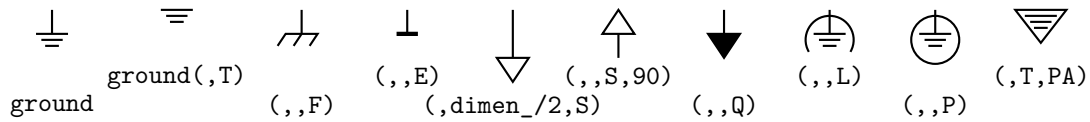

Figure 26: The `ground(at position, T|stem length, N|F|S|L|P[A]|E, U|D|L|R|degrees)` macro.

The arguments of `antenna(at position, T|stem length, A|L|T|S|D|P|F, U|D|L|R|degrees)` shown in Figure 27 are similar to those of `ground`.

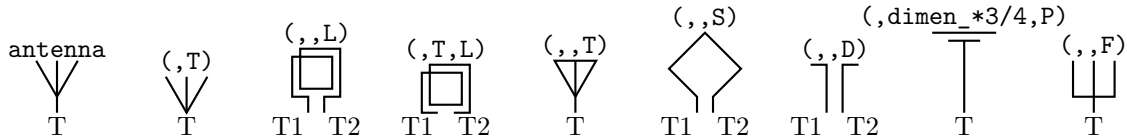

Figure 27: Antenna symbols, with macro arguments shown above and terminal names below.

Figure 28 illustrates the macro `opamp(linespec, - label, + label, size, chars)`. The element is enclosed in a block containing the predefined internal locations shown. These locations can

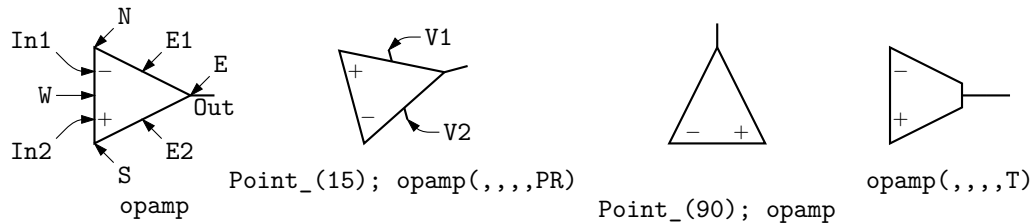

Figure 28: Operational amplifiers. The P option adds power connections. The second and third arguments can be used to place and rotate arbitrary text at `In1` and `In2`.

be referenced in later commands, for example as “`last [] .Out.`” The first argument defines the direction and length of the opamp, but the position is determined either by the enclosing block of the opamp, or by a construction such as “`opamp with .In1 at Here`”, which places the internal position `In1` at the specified location. There are optional second and third arguments for which the defaults are `\scriptsize$-$` and `\scriptsize$+$` respectively, and the fourth argument changes the size of the opamp. The fifth argument is a string of characters. P adds a power connection, R exchanges the second and third entries, and T truncates the opamp point.

Typeset text associated with circuit elements is not rotated by default, as illustrated by the second and third opamps in Figure 28. The `opamp` labels can be rotated if necessary by using postprocessor commands (for example `PSTricks \rput`) as second and third arguments.

The code in Figure 29 places an opamp with three connections.

```

line right 0.2 then up 0.1
A: opamp(up_.,.,0.4,R) with .In1 at Here
  line right 0.2 from A.Out
  line down 0.1 from A.In2 then right 0.2

```

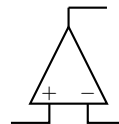

Figure 29: A code fragment invoking the `opamp(linespec,-,+,size,[R][P])` macro.

Figure 30 shows variants of the transformer macro, which has predefined internal locations `P1`, `P2`, `S1`, `S2`, `TP`, and `TS`. The first argument specifies the direction and distance from `P1` to `P2`, with position determined by the enclosing block as for opamps. The second argument places the secondary side of the transformer to the left or right of the drawing direction. The optional third and fifth arguments specify the number of primary and secondary arcs respectively. If the fourth

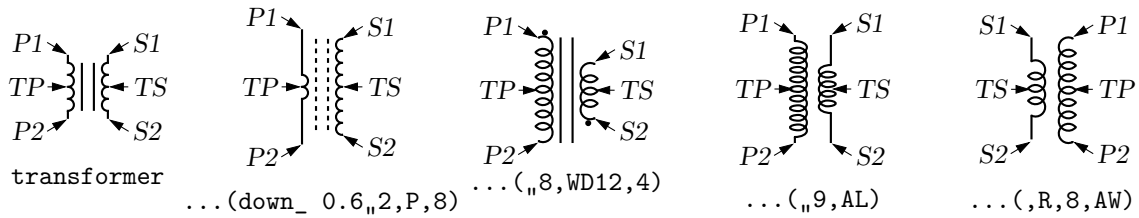

Figure 30: The `transformer` (*linespec*, *L*|*R*, *np*, [*A*|*P*] [*W*|*L*] [*D1*|*D2*|*D12*|*D21*], *ns*) macro (drawing direction down), showing predefined terminal and centre-tap points.

argument string contains an *A*, the iron core is omitted; if a *P*, the core is dashed (powder); and if it contains a *W*, wide windings are drawn. A *D1* puts phase dots at the *P1*, *S1* end, *D2* at the *P2*, *S2* ends, and *D12* or *D21* puts dots at opposite ends.

Figure 31 shows some audio devices, defined in `[]` blocks, with predefined internal locations as shown. The first argument specifies the device orientation. Thus,

`S: speaker(U)` with `.In2` at Here places an upward-facing speaker with input *In2* at the current location.

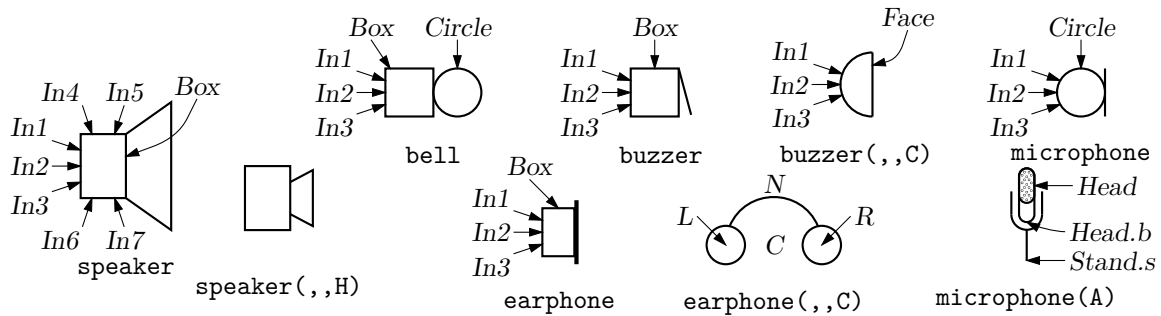

Figure 31: Audio components: `speaker` (*U*|*D*|*L*|*R*|*degrees*, *size*, *type*), `bell`, `microphone`, `buzzer`, `earphone`, with their internally named positions and components.

The `nport` (*box specs* [*;* *other commands*], *nw*, *nn*, *ne*, *ns*, *space ratio*, *pin lgth*, *style*) macro is shown in **Figure 32**. The macro begins with the line `define('nport', '[Box: box '$1', so the`

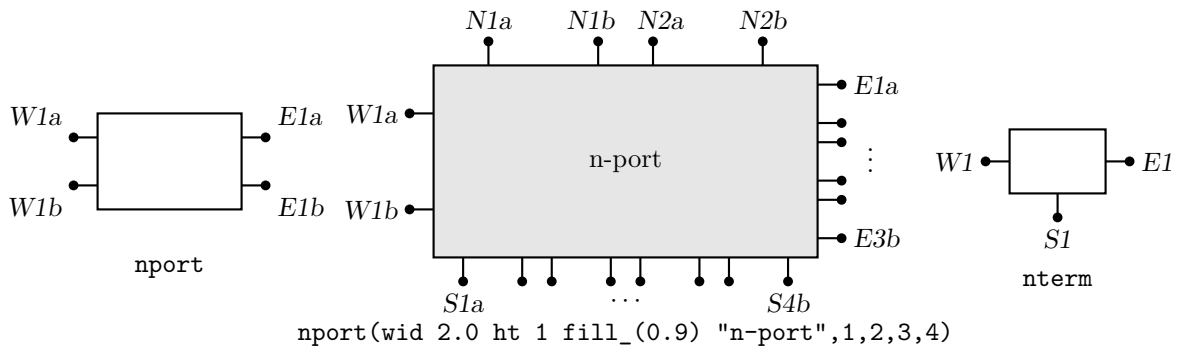

Figure 32: The `nport` macro draws a sequence of pairs of named pins on each side of a box. The pin names are shown. The default is a twoport. The `nterm` macro draws single pins instead of pin pairs.

first argument is a box specification such as `size`, `fill`, or `text`. The second to fifth arguments specify the number of ports (pin pairs) to be drawn respectively on the west, north, east, and south sides of the box. The end of each pin is named according to the side, port number, and *a* or *b* pin, as shown. The sixth argument specifies the ratio of port width to inter-port space, the seventh is the

pin length, and setting the eighth argument to `N` omits the pin dots. The macro ends with `'$9']')`, so that a ninth argument can be used to add further customizations within the enclosing block.

The `nterm(box specs, nw, nn, ne, ns, pin lgth, style)` macro illustrated in Figure 32 is similar to the `nport` macro but has one fewer argument, draws single pins instead of pin pairs, and defaults to a 3-terminal box.

Many custom labels or added elements may be required, particularly for 2-ports. These elements can be added using the first argument and the ninth of the `nport` macro. For example, the following code adds a pair of labels to the box immediately after drawing it but within the enclosing block:

```
nport(;"0" at Box.w ljust;"∞" at Box.e rjust)
```

If this trick were to be used extensively, then the following custom wrapper would save typing, add the labels, and pass all arguments to `nport`:

```
define('nullor','nport('$1'
{"${}0$"} at Box.w ljust
{"$\infty$"} at Box.e rjust},shift($@))')
```

The above example and the related `gyrator` macro are illustrated in Figure 33.

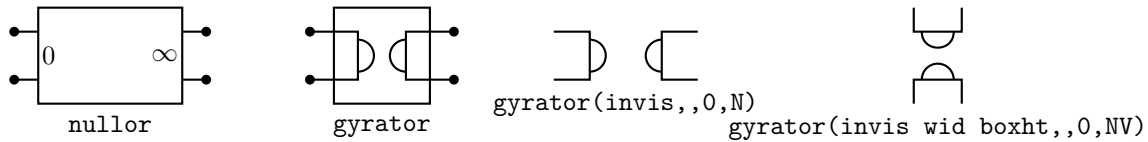

Figure 33: The `nullor` example and the `gyrator` macro are customizations of the `nport` macro.

Figure 34 shows the macro `contact(chars)`, which contains predefined locations `P`, `C`, `O` for the armature and normally closed and normally open terminals. An `I` in the first argument draws open circles for contacts.

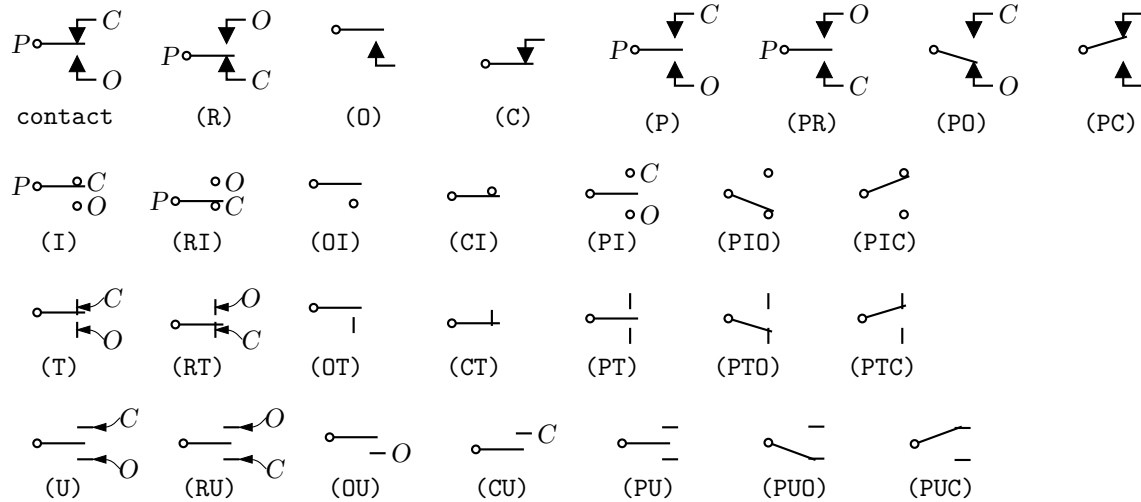

Figure 34: The `contact(chars)` macro (default drawing direction right) can be used alone, in a set of ganged contacts, or in relays.

The `contacts(poles, chars)` macro in Figure 35 draws multiple contacts.

For drawing relays, the macro `relaycoil(chars, wid, ht, U|D|L|R|degrees)` shown in Figure 36 provides a choice of connection points and actuator types.

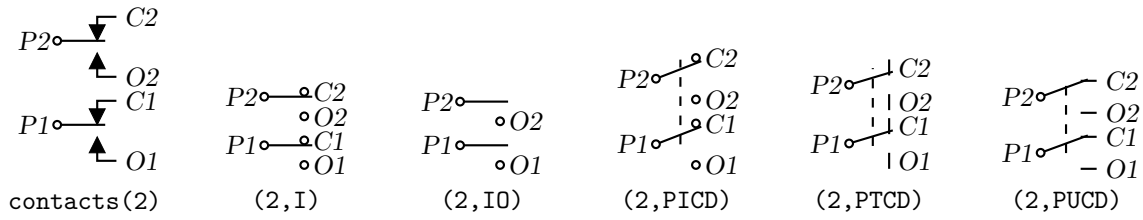

Figure 35: The contacts(*poles, chars*) macro (drawing direction right).

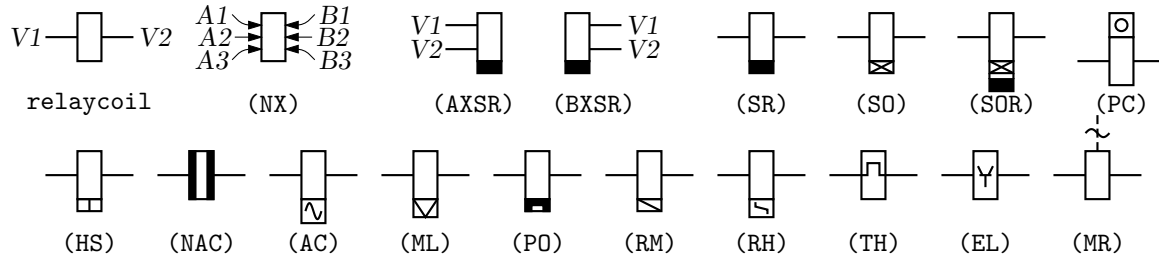

Figure 36: The relaycoil macro.

The relay(*poles, chars*) macro in Figure 37 defines coil terminals V1, V2 and contact terminals P_i, C_i, O_i.

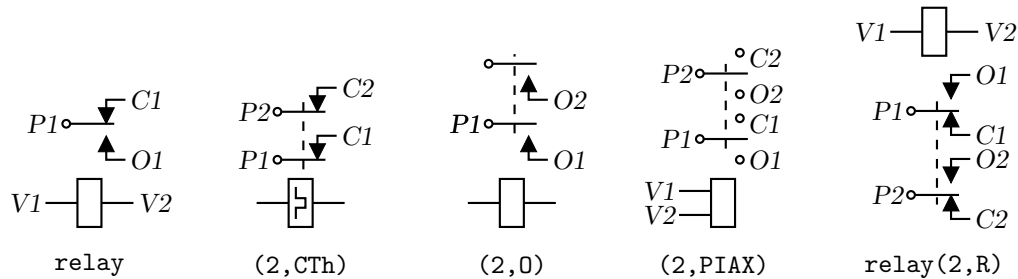

Figure 37: The relay(*poles, chars*) macro (drawing direction right).

The jack and plug macros and their defined points are illustrated in Figure 38. The first argument of both macros establishes the drawing direction. The second argument is a string of

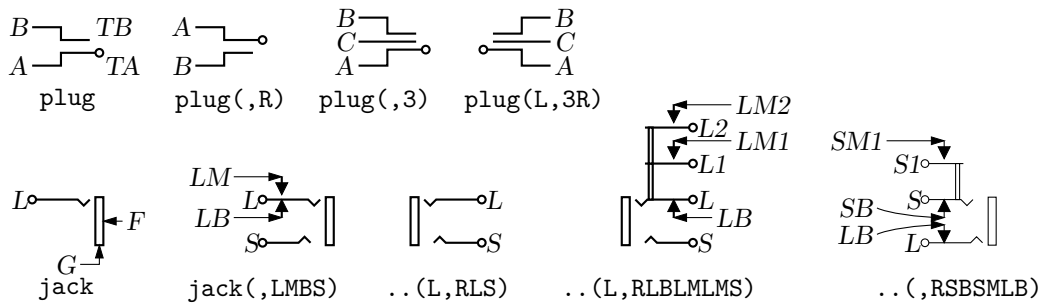

Figure 38: The jack(*U|D|L|R|degrees, chars*) and plug(*U|D|L|R|degrees, [2|3][R]*) components and their defined points.

characters defining drawn components. An R in the string specifies a right orientation with respect to the drawing direction. The two principal terminals of the jack are included by putting L S or both into the string with associated make (M) or break (B) points. Thus, LMB within the third argument

draws the L contact with associated make and break points. Repeated L[M|B] or S[M|B] substrings add auxiliary contacts with specified make or break points.

A macro for drawing headers is in [Figure 39](#), and some experimental connectors are shown in [Figure 40](#) and [Figure 41](#). The `tstrip` macro allows “key=value;” arguments for width and height.

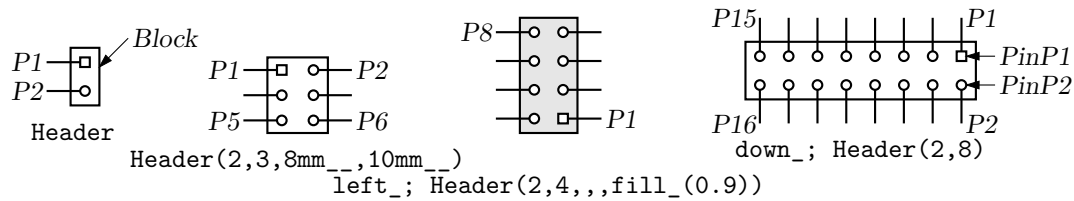

Figure 39: Macro `Header(1|2, rows, wid, ht, type)`.

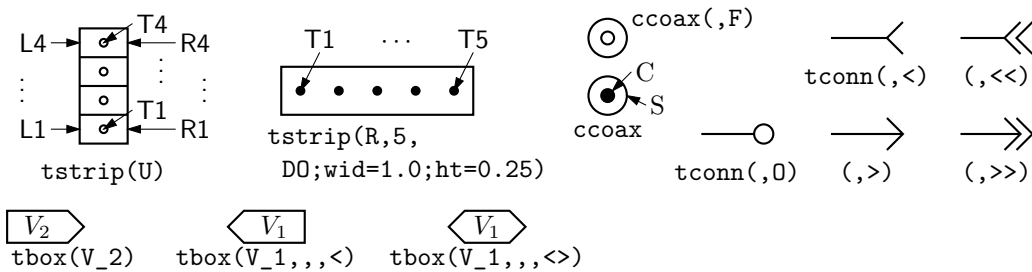

Figure 40: Macros `tstrip(R|L|U|D|degrees, chars)`, `ccoax(at location, M|F, diameter)`, `tconn(linespec, >|>|<|<|0[F], wid)`, and `tbox(text, wid, ht, <|>|<>,type)`.

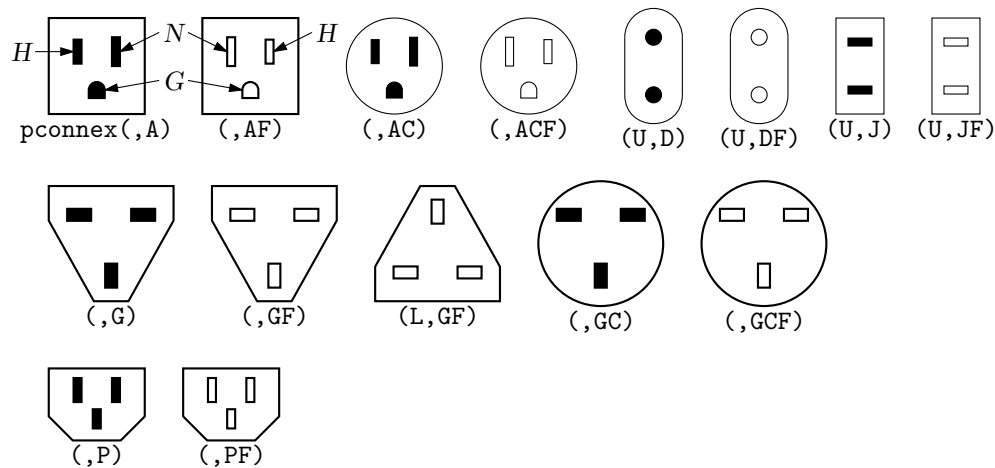

Figure 41: A small set of power connectors drawn by `pconnex(R|L|U|D|degrees, chars)`. Each connector has an internal H, N, and where applicable, a G shape.

The double-throw switches shown in [Figure 42](#) are drawn in the current drawing direction like the two-terminal elements, but are composite elements that must be placed accordingly.

A basic winding macro for magnetic-circuit sketches and similar figures is shown in [Figure 43](#). For simplicity, the complete spline is first drawn and then blanked in appropriate places using the background (core) color (`lightgray` for example, default `white`).

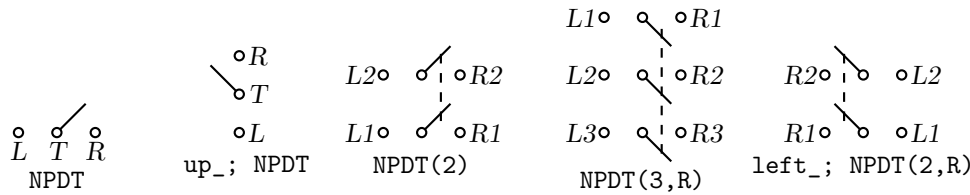

Figure 42: Multipole double-throw switches drawn by `NPDT(npoles, [R])`.

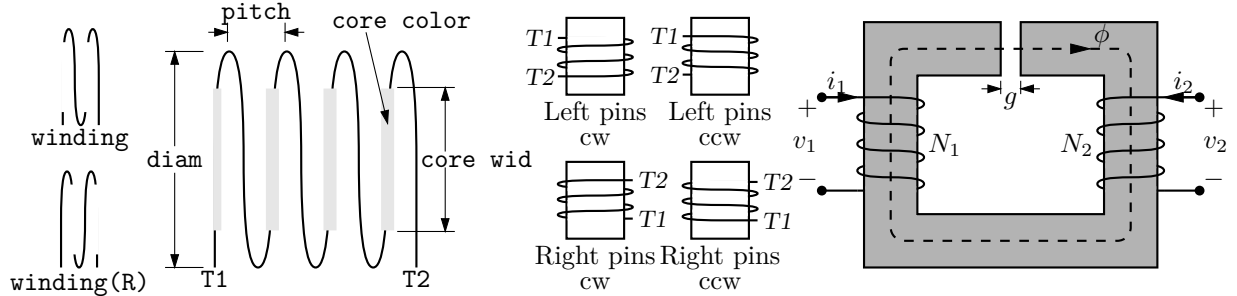

Figure 43: The `winding(L|R, diam, pitch, turns, core wid, core color)` macro draws a coil with axis along the current drawing direction. Terminals T1 and T2 are defined. Setting the first argument to R draws a right-hand winding.

6.1 Semiconductors

Figure 44 shows the variants of bipolar transistor macro `bi_tr(linespec,L|R,P,E)` which contains predefined internal locations *E*, *B*, *C*. The first argument defines the distance and direction from *E* to *C*, with location determined by the enclosing block as for other elements, and the base placed to

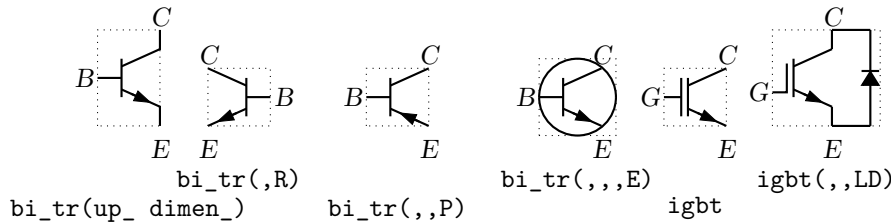

Figure 44: Variants of bipolar transistor `bi_tr(linespec,L|R,P,E)` (current direction upward).

the left or right of the current drawing direction according to the second argument. Setting the third argument to P creates a PNP device instead of NPN, and setting the fourth to E draws an envelope around the device. Figure 45 shows a composite macro with several optional internal elements.

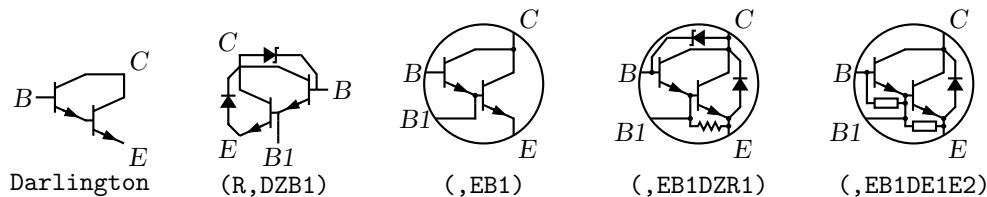

Figure 45: Macro `Darlington(L|R, [E] [P] [B1] [E1|R1] [E2|R2] [D] [Z])`, drawing direction up_.

The code fragment example in Figure 46 places a bipolar transistor, connects a ground to the emitter, and connects a resistor to the collector.

The `bi_tr` and `igbt` macros are wrappers for the macro `bi_trans(linespec, L|R, chars, E)`, which draws the components of the transistor according to the characters in its third argument. For example, multiple emitters and collectors can be specified as shown in Figure 47.

```

S: dot; line left_ 0.1; up_
Q1: bi_tr(R) with .B at Here
ground(at Q1.E)
line up 0.1 from Q1.C; resistor(right_ S.x-Here.x); dot

```

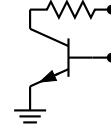

Figure 46: The `bi_tr(linespec,L|R,P,E)` macro.

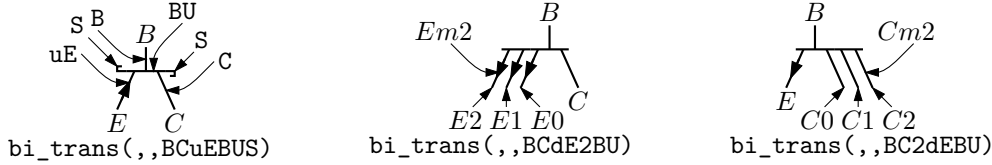

Figure 47: The `bi_trans(linespec,L|R,chars,E)` macro. The sub-elements are specified by the third argument. The substring E_n creates multiple emitters E_0 to E_n . Collectors are similar.

A UJT macro with predefined internal locations B_1 , B_2 , and E is shown in Figure 48.

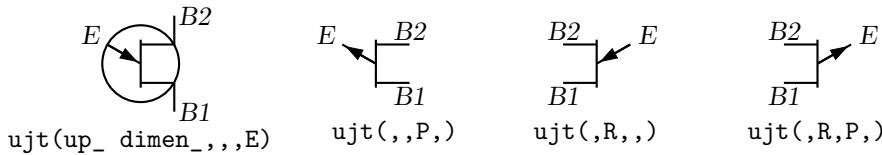

Figure 48: UJT devices, with current drawing direction `up_`.

A thyristor macro with predefined internal locations G and T_1 , T_2 , or A , K is in Figure 49. Except for the G terminal, a thyristor (the IEC variant excluded) is much like a two-terminal

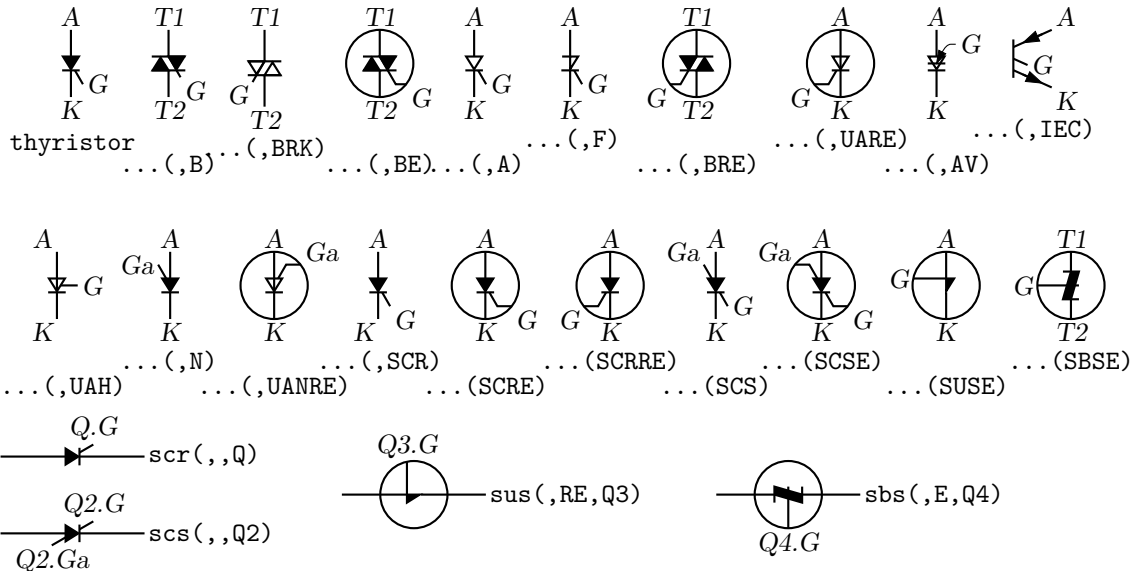

Figure 49: The top two rows illustrate use of the `thyristor(linespec, chars)` macro, drawing direction `down_`, and the bottom row shows wrapper macros (drawing direction `right_`) that place the thyristor like a two-terminal element. Append K to the second argument to draw open arrowheads.

element. The wrapper macro `scr(linespec, chars, label)` and similar macros `sbs`, `sus`, and `sbs` place thyristors using `linespec` as for a two-terminal element, but require a third argument for the label for the compound block; thus,

`scr(from A to B,,Q3); line right from Q3.G`
 draws the element from position *A* to position *B* with label *Q3*, and draws a line from *G*.
 Some FETs with predefined internal locations *S*, *D*, and *G* are also included, with similar arguments to those of `bi_tr`, as shown in [Figure 50](#). In all cases the first argument is a *linespec*,

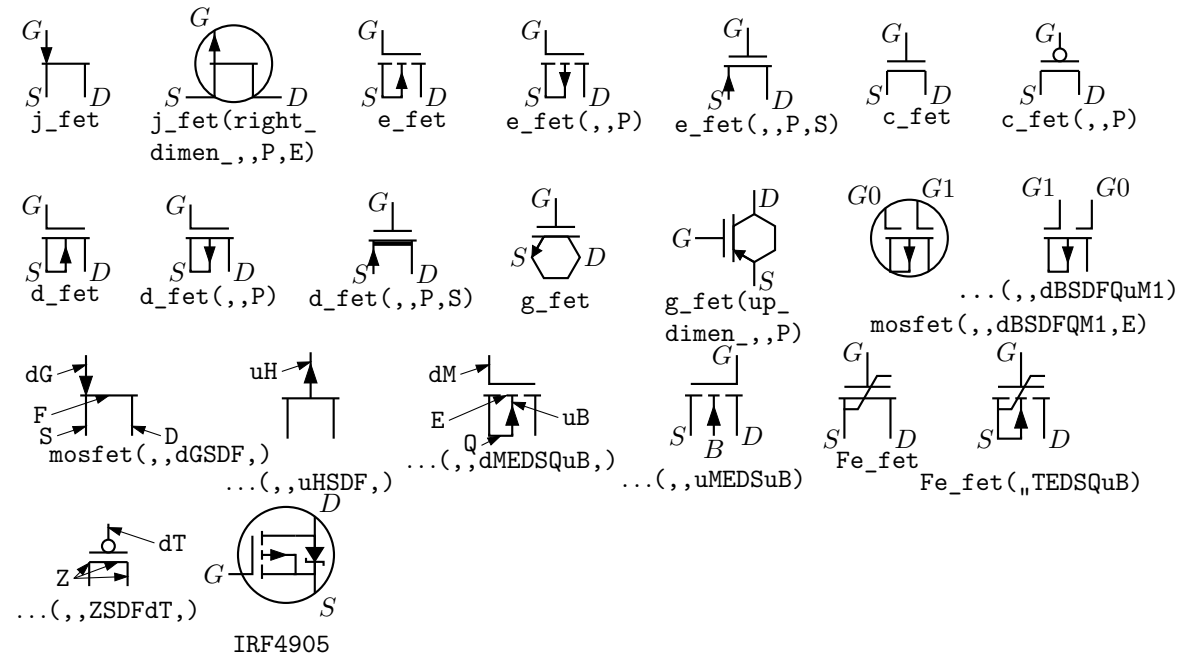

Figure 50: JFET, insulated-gate enhancement and depletion MOSFETs, simplified versions, graphene, and ferroelectric fetts. These macros are wrappers that invoke the `mosfet` macro as shown in the middle and bottom rows. The bottom-row examples show custom devices, the first defined by omitting the substrate connection, and the second defined using a wrapper macro.

and entering *R* as the second argument orients the *G* terminal to the right of the current drawing direction. The macros in the top three rows of the figure are wrappers for the general macro `mosfet(linespec,R,characters,E)`. The third argument of this macro is a subset of the characters {BDEFGMLQRSTYZ}, each letter corresponding to a diagram component as shown in the bottom row of the figure. Preceding the characters *B*, *G*, and *S* by *u* or *d* adds an up or down arrowhead to the pin, preceding *T* by *d* negates the pin, and preceding *M* by *u* or *d* puts the pin at the drain or source end respectively of the gate. The obsolete letter *L* is equivalent to *dM* and has been kept temporarily for compatibility. This system allows considerable freedom in choosing or customizing components, as illustrated in [Figure 50](#).

The number of possible semiconductor symbols is very large, so these macros must be regarded as prototypes. Often an element is a minor modification of existing elements. For example, the `thyristor(linespec, chars)` macro illustrated in [Figure 49](#) is derived from the diode and bipolar transistor macros. Another example is the `tgate` macro shown in [Figure 51](#), which also shows a pass transistor.

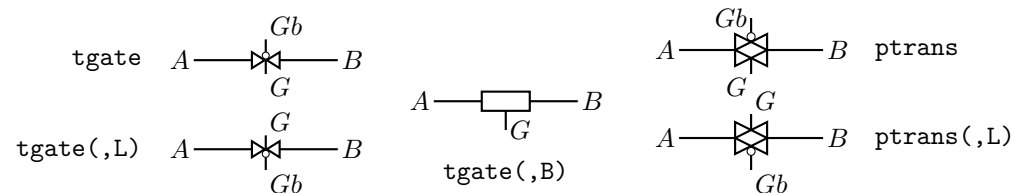

Figure 51: The `tgate(linespec, [B] [R|L])` element, derived from a customized diode and `ebox`, and the `ptrans(linespec, [R|L])` macro. These are not two-terminal elements, so the *linespec* argument defines the direction and length of the line from *A* to *B* but not the element position.

Some other non-two-terminal macros are `dot`, which has an optional argument “at *location*”, the line-thickness macros, the `fill_` macro, and `crossover`, which is a useful if archaic method to show non-touching conductor crossovers, as in [Figure 52](#).

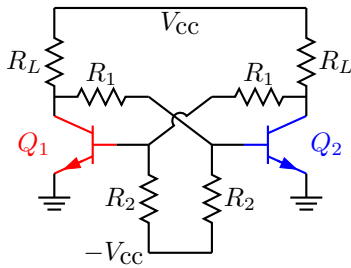

Figure 52: Bipolar transistor circuit, illustrating `crossover` and colored elements.

This figure also illustrates how elements and labels can be colored using the macro `rgbdraw(r, g, b, drawing commands)` where the *r*, *g*, *b* values are in the range 0 to 1 (integers from 0 to 255 for SVG) to specify the rgb color. This macro is a wrapper for the following, which may be more convenient if many elements are to be given the same color:

```
setrgb(r, g, b)
drawing commands
resetrgb
```

A macro is also provided for colored fills:

```
rgbfill(r, g, b, drawing commands)
```

These macros depend heavily on the postprocessor and are intended only for PSTricks, Tikz PGF, MetaPost, SVG, and the Postscript or PDF output of dpic. Basic Pic objects are probably best colored and filled as discussed in [Section 3.4](#).

7 Corners

If two straight lines meet at an angle then, depending on the postprocessor, the corner may not be mitred or rounded unless the two lines belong to a multisegment line, as illustrated in [Figure 53](#). This

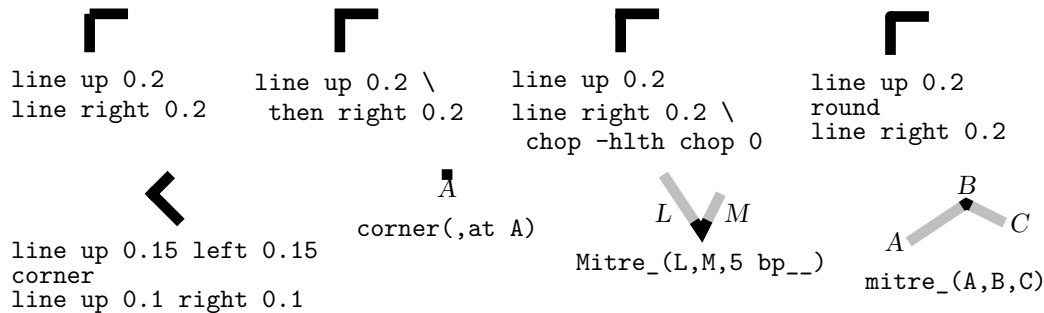

Figure 53: Producing mitred angles and corners.

is normally not an issue for circuit diagrams unless the figure is magnified or thick lines are drawn. Rounded corners can be obtained by setting post-processor parameters, but the figure shows the effect of macros `round` and `corner`. The macros `mitre_(Position1,Position2,Position3,length,attributes)` and `Mitre_(Line1,Line2,length,attributes)` may assist as shown. Otherwise, a right-angle line can be extended by half the line thickness (macro `hlth`) as shown on the upper row of the figure, or a two-segment line can be overlaid at the corner to produce the same effect.

8 Looping

Sequential actions can be performed using either the `dpic` command

```
for variable=expression to expression [by expression] do { actions }
```

or at the `m4` processing stage. The `libgen` library defines the macro

```
for_(start, end, increment, 'actions')
```

for this and other purposes. Nested loops are allowed and the innermost loop index variable is `m4x`. The first three arguments must be integers and the `end` value must be reached exactly; for example, `for_(1,3,2,'print In'm4x')` prints locations `In1` and `In3`, but `for_(1,4,2,'print In'm4x')` does not terminate since the index takes on values 1, 3, 5, ...

Repetitive actions can also be performed with the `libgen` macro

```
Loopover_('variable', actions, value1, value2, ...)
```

which evaluates `actions` for each instance of `variable` set to `value1`, `value2`, ...

9 Logic gates

Figure 54 shows the basic logic gates included in library `liblog.m4`. The first argument of the gate macros can be an integer N from 0 to 16, specifying the number of input locations `In1`, ... `InN`, as illustrated for the NOR gate in the figure. By default, $N = 2$ except for macros `NOT_gate` and `BUFFER_gate`, which have one input `In1` unless they are given a first argument, which is treated as the line specification of a two-terminal element.

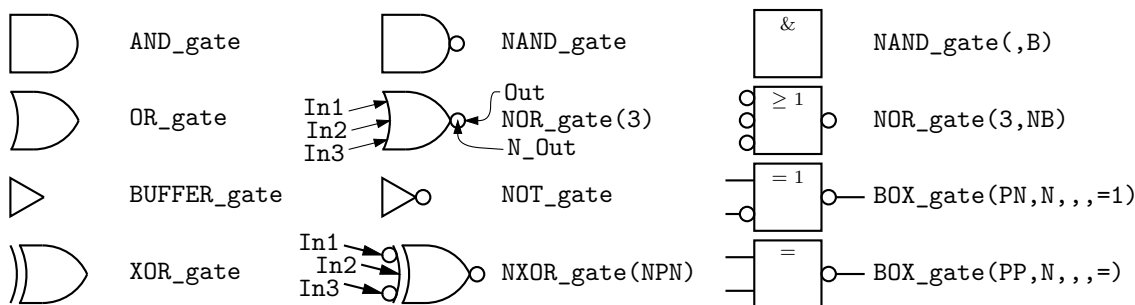

Figure 54: Basic logic gates. The input and output locations of a three-input NOR gate are shown. Inputs are negated by including an `N` in the second argument letter sequence. A `B` in the second argument produces a box shape as shown in the rightmost column, where the second example has AND functionality and the bottom two are examples of exclusive OR functions.

Input locations retain their positions relative to the gate body regardless of gate orientation, as in Figure 55. Beyond a default number (6) of inputs, the gates are given wings as in Figure 56.

```
.PS
# 'FF.m4'
log_init
S: NOR_gate
  left_
R: NOR_gate at S+(0,-L_unit*(AND_ht+1))
  line from S.Out right L_unit*3 then down S.Out.y-R.In2.y then to R.In2
  line from R.Out left L_unit*3 then up S.In2.y-R.Out.y then to S.In2
  line left 4*L_unit from S.In1 ; "$$$sp_" rjust
  line right 4*L_unit from R.In1 ; "sp_$$" ljust
.PE
```

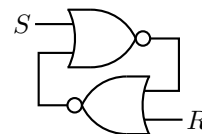

Figure 55: *SR* flip-flop.

Negated inputs or outputs are marked by circles drawn using the `NOT_circle` macro. The name marks the point at the outer edge of the circle and the circle itself has the same name prefixed by `N_`. For example, the output circle of a nand gate is named `N_Out` and the outermost point of the circle is named `Out`. Instead of a number, the first argument can be a sequence of letters `P` or `N`

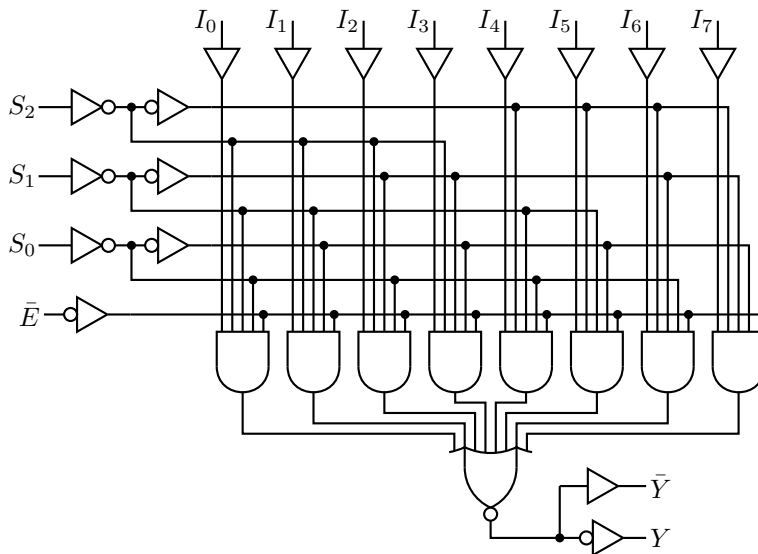

Figure 56: Eight-input multiplexer, showing a gate with wings.

to define normal or negated inputs; thus for example, `NXOR_gate(NPN)` defines a 3-input nxor gate with not-circle inputs `In1` and `In3` and normal input `In2` as shown in the figure. The macro `IOdefs` can also be used to create a sequence of custom named inputs or outputs.

Gates are typically not two-terminal elements and are normally drawn horizontally or vertically (although arbitrary directions may be set with e.g. `Point_(degrees)`). Each gate is contained in a block of typical height `6*L_unit` where `L_unit` is a macro intended to establish line separation for an imaginary grid on which the elements are superimposed.

Including an `N` in the second argument character sequence of any gate negates the inputs, and including `B` in the second argument invokes the general macro `BOX_gate([P|N] . . . , [P|N] , horiz size , vert size , label)`, which draws box gates. Thus, `BOX_gate(PNP,N,8,\geq 1)` creates a gate of default width, eight `L_units` height, negated output, three inputs with the second negated, and internal label “ ≥ 1 ”. If the fifth argument begins with `sprintf` or a double quote then the argument is copied literally; otherwise it is treated as `scriptsize mathematics`.

A good strategy for drawing complex logic circuits might be summarized as follows:

- Establish the absolute locations of gates and other major components (e.g. chips) relative to a grid of mesh size commensurate with `L_unit`, which is an absolute length.
- Draw minor components or blocks relative to the major ones, using parameterized relative distances.
- Draw connecting lines relative to the components and previously drawn lines.
- Write macros for repeated objects.
- Tune the diagram by making absolute locations relative, and by tuning the parameters. Some useful macros for this are the following, which are in units of `L_unit`:

`AND_ht`, `AND_wd`: the height and width of basic AND and OR gates

`BUF_ht`, `BUF_wd`: the height and width of basic buffers

`N_diam`: the diameter of NOT circles

The macro `BUFFER_gate(linespec , [N|B] , wid , ht , [N|P]* , [N|P]*)` is a wrapper for the composite element `BUFFER_gen`. If the second argument is `B`, then a box gate is drawn; otherwise the gate is triangular. Arguments 5 and 6 determine the number of defined points along the northeast and southeast edges respectively, with an `N` adding a NOT circle. If the first argument is non-blank however, then the buffer is drawn along an invisible line like a two-terminal element, which is convenient sometimes but requires internal locations of the block to be referenced using `last []`, as shown in [Figure 57](#).

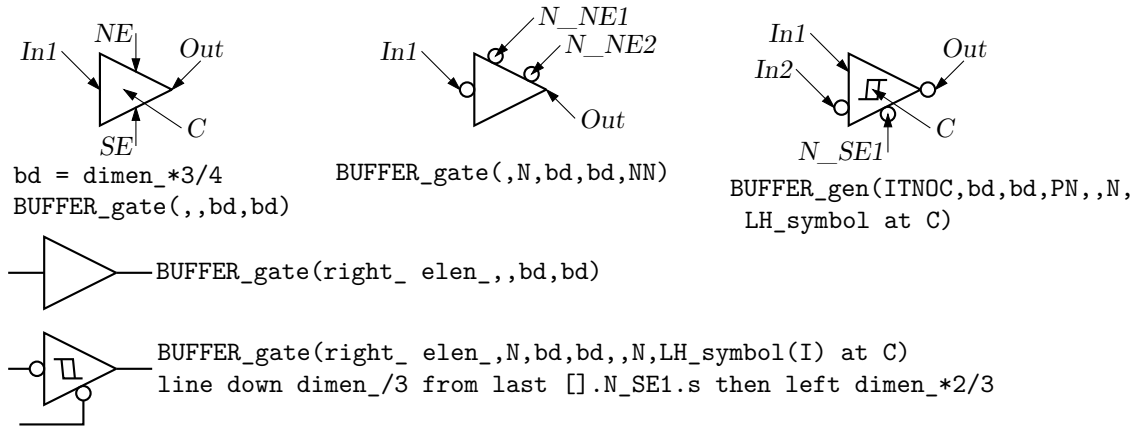

Figure 57: The BUFFER_gate and BUFFER_gen macros. The bottom two examples show how the gate can be drawn as a two-terminal macro but internal block locations must be referenced using last [].

Figure 58 shows the macro FlipFlop(D|T|RS|JK, label, boxspec, pinlength), which is a wrapper for the more general macro FlipFlopX(boxspec, label, leftpins, toppins, rightpins, bottompins, pinlength). The first argument modifies the box (labelled Chip) default specification. Each of

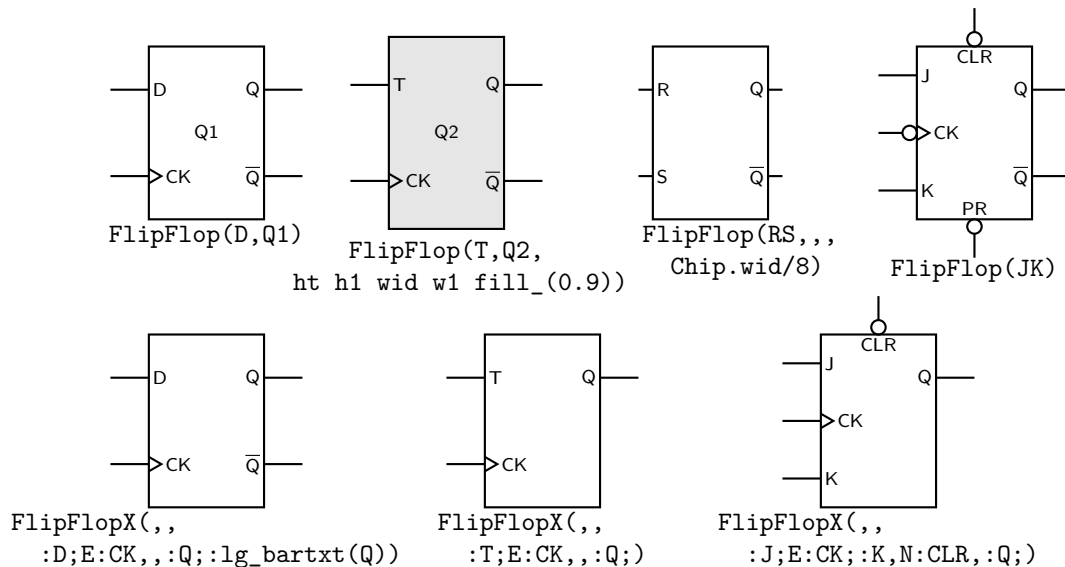

Figure 58: The FlipFlop and FlipFlopX macros, with variations.

arguments 3 to 6 is null or a string of pinspecs separated by semicolons (;). A pinspec is either empty (null) or of the form [pinopts]:[label[:Picname]]. The first colon draws the pin. Pins are placed top to bottom or left to right along the box edges with null pinspecs counted for placement. Pins are named by side and number by default; eg W1, W2, ..., N1, N2, ..., E1, ..., S1, ...; however, if :Picname is present in a pinspec then Picname replaces the default name. A pinspec label is text placed at the pin base. Semicolons are not allowed in labels; use e.g., \char59{} instead. To put a bar over a label, use lg_bartxt(label). The pinopts are [L|M|I|O][N][E] as for the lg_pin macro. Optional argument 7 is the pin length in drawing units.

Figure 59 shows a multiplexer block with variations, and Figure 60 shows the very similar demultiplexer.

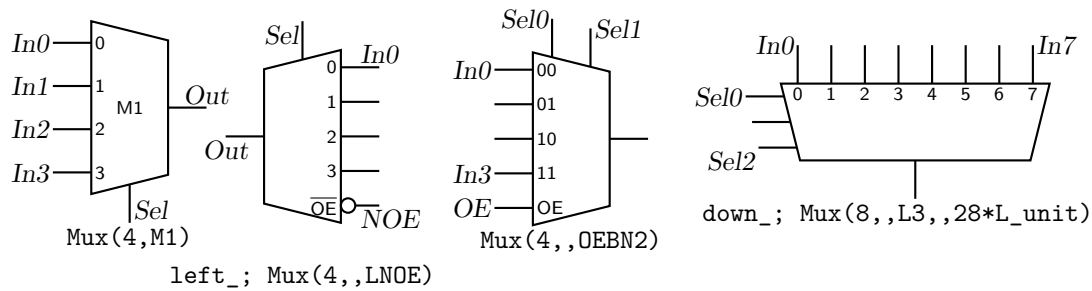

Figure 59: The Mux(input count, label, [L] [B|H|X] [N[n] |S[n]] [[N]OE], wid, ht) macro.

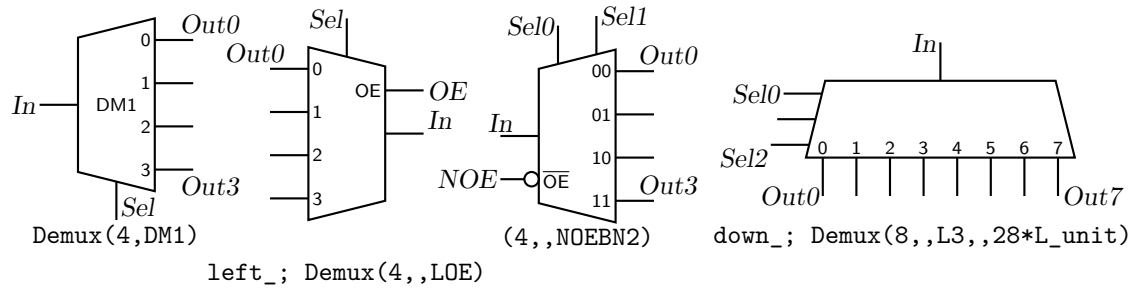

Figure 60: The Demux(input count, label, [L] [B|H|X] [N[n] |S[n]] [[N]OE], wid, ht) macro.

Customized gates can be defined simply. For example, the following code defines the custom flipflops in Figure 61.

```
define('customFF', 'FlipFlopX(wid 10*L_unit ht FF_ht*L_unit, ,
    :S;NE:CK;:R, N:PR, :Q;;ifelse('$1',1,:lg_bartxt(Q)), N:CLR) ')
```

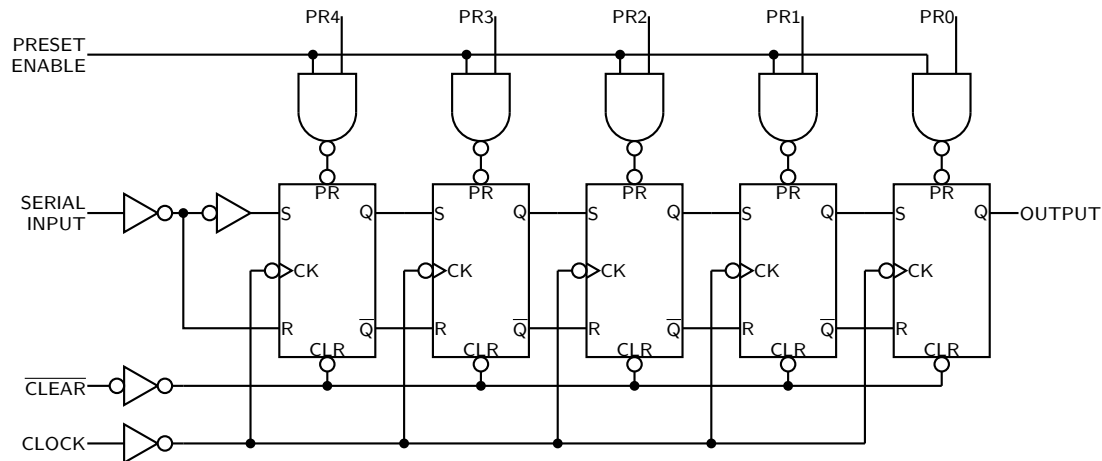

Figure 61: A 5-bit shift register.

This definition makes use of macros L_unit and FF_ht that predefine default dimensions. There are three pins on the right; the centre pin is null and the bottom is null if the first macro argument is 1.

For hybrid applications, the dac and adc macros are illustrated in Figure 62. The figure shows the default and predefined internal locations, the number of which can be specified as macro arguments.

In addition to the logic gates described here, some experimental IC chip diagrams are included with the distributed example files.

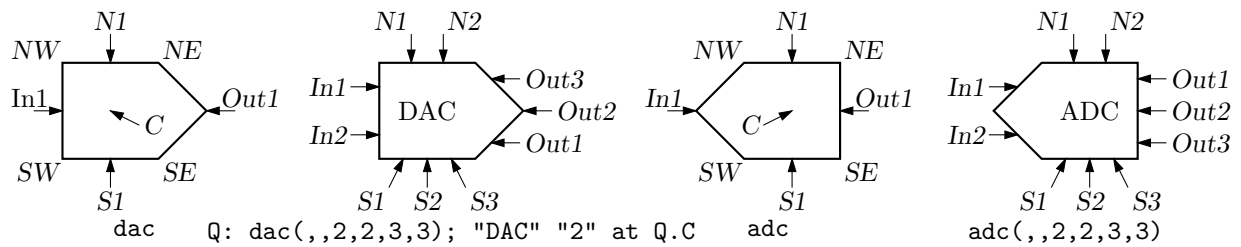

Figure 62: The `dac(width,height,nIn,nN,nOut,nS)` and `adc(width,height,nIn,nN,nOut,nS)` macros.

10 Integrated circuits

Developing a definitive library of integrated circuits is problematic because context may determine how they should be drawn. Logical clarity may require drawing a functional diagram in which the connection pins are not in the physical order of a terminal diagram, for example. Circuit boards and connectors are similar. Although the geometries are simple, managing lists of pin locations and labels can be tedious and repetitive.

The many-argument macro `lg_pin(location, label, Picname, n|e|s|w [L|M|I|O] [N] [E], pinno, optional length)` can be used to draw a variety of pins as illustrated in the Figure 63. To draw the left-side pins, for example, one can write

```
lg_pin( U.nw-(0,lg_pinsep), Vin, Pin1, w )
lg_pin( U.nw-(0,2*lg_pinsep),,, wL )
```

and so on. Each pin can also be given a pic name, some text to indicate function, and a number.

```
.PS
log_init
command "\small\sif"

U: box wid 18*L_unit ht 9*lg_pinsep

Loopover_('x',
  'lg_pin(U.nw-(0,m4Lx*lg_pinsep),,,w'x)',
  nul,L,M,I,O,N,E,NE)

define('Upin',
  'lg_pin(U.ne-(0,(17-'$1')*lg_pinsep),'$2',Pin'$1',e'$3','$1',8*L_unit)')
Loopover_('x',
  'Upin(patsubst(x,;,''))',
  16;Vin;, 15;D0;L, 14;D1;M, 13;D2;I, 12;D3;O, 11;D4;N, 10;D5;E, 9;D6;NE )
.PE
```

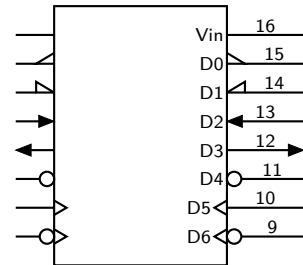

Figure 63: An imaginary 16-pin integrated circuit and its code. Pin variations defined by the first `Loopover_` are shown on the left; and text, pic labels, and pin numbers are defined on the right. The third and successive arguments of the second `Loopover_` are ;-separated pin number, text, and pin type. The semicolons are changed to commas by the `patsubst m4` macro and the `Upin` macro gives the resulting arguments to `lg_pin`.

To reduce the tedium of adding the pins by hand, a list can be given to the `Loopover_('variable', 'actions', value1, value2, ...)` which executes the given actions successively with `variable = value1, value2 ...` and the counter `m4Lx` set to 1, 2, ... as in the diagram.

11 Element and diagram scaling

There are several issues related to scale changes. You may wish to use millimetres, for example, instead of the default inches. You may wish to change the size of a complete diagram while keeping

the relative proportions of objects within it. You may wish to change the sizes or proportions of individual elements within a diagram. You must take into account that the size of typeset text is independent of the pic language except when svg is being produced, and that line widths are independent of the scaling of drawn objects.

The scaling of circuit elements will be described first, then the pic scaling facilities.

11.1 Circuit scaling

The circuit elements all have default dimensions that are multiples of the pic environmental parameter `linewidth`, so changing this parameter changes default element dimensions. The scope of a pic variable is the current block; therefore, a sequence such as

```
resistor
T: [linewidth = linewidth*1.5; up_; Q: bi_tr] with .Q.B at Here
ground(at T.Q.E)
resistor(up_ dimen_ from T.Q.C)
```

connects two resistors and a ground to an enlarged transistor. Alternatively, you may redefine the default length `elen_` or the body-size parameter `dimen_`. For example, adding the line

```
define('dimen_', (dimen_*1.2))
```

after the `cct_init` line of `quick.m4` produces slightly larger body sizes for all circuit elements. For logic elements, the equivalent to the `dimen_` macro is `L_unit`, which has default value `(linewidth/10)`.

The macros `capacitor`, `inductor`, and `resistor` have arguments that allow the body sizes to be adjusted individually. The macro `resized` mentioned previously can also be used.

11.2 Pic scaling

There are at least three kinds of graphical elements to be considered:

1. When generating final output after reading the `.PE` line, pic processors divide distances and sizes by the value of the environmental parameter `scale`, which is 1 by default. Therefore, the effect of assigning a value to `scale` at the beginning of the diagram is to change the drawing unit (initially 1 inch) throughout the figure. For example, the file `quick.m4` can be modified to use millimetres as follows:

```
.PS                                # Pic input begins with .PS
scale = 25.4                        # mm
cct_init                            # Set defaults

elen = 19                            # Variables are allowed
...
```

The default sizes of pic objects are redefined by assigning new values to the environmental parameters `arcrad`, `arrowht`, `arrowwid`, `boxht`, `boxrad`, `boxwid`, `circrad`, `dashwid`, `ellipseht`, `ellipsewid`, `lineht`, `linewidth`, `moveht`, `movewid`, `textht`, and `textwid`. The `...ht` and `...wid` parameters refer to the default sizes of vertical and horizontal lines, moves, etc., except for `arrowht` and `arrowwid`, which are arrowhead dimensions. The `boxrad` parameter can be used to put rounded corners on boxes. Assigning a new value to `scale` also multiplies all of these parameters except `arrowht`, `arrowwid`, `textht`, and `textwid` by the new value of `scale` (gpics multiplies them all). Therefore, objects drawn to default sizes are unaffected by changing `scale` at the beginning of the diagram. To change default sizes, redefine the appropriate parameters explicitly.

2. The `.PS` line can be used to scale the entire drawing, regardless of its interior. Thus, for example, the line `.PS 100/25.4` scales the entire drawing to a width of 100 mm. Line thickness, text size, and dpic arrowheads are unaffected by this scaling.

If the final picture width exceeds `maxpswid`, which has a default value of 8.5, then the picture is scaled to this size. Similarly, if the height exceeds `maxpsht` (default 11), then the picture is scaled to fit. These parameters can be assigned new values as necessary, for example, to accommodate landscape figures.

3. The finished size of typeset text is independent of pic variables, but can be determined as in [Section 13](#). Then, `"text" wid x ht y` tells pic the size of `text`, once the printed width x and height y have been found.
4. Line widths are independent of diagram and text scaling, and have to be set explicitly. For example, the assignment `linethick = 1.2` sets the default line width to 1.2pt. The macro `linethick_(points)` is also provided, together with default macros `thicklines_` and `thinlines_`.

12 Writing macros

The m4 language is quite simple and is described in numerous documents such as the original reference [9] or in later manuals [15]. If a new circuit or other element is required, then it may suffice to modify and rename one of the library definitions or simply add an option to it. Hints for drawing general two-terminal elements are given in `libcct.m4`. However, if an element or block is to be drawn in only one orientation then most of the elaborations used for general two-terminal elements in [Section 4](#) can be dropped. If you develop a library of custom macros in the installation directory then the statement `include(mylibrary.m4)` can bring its definitions into play.

It may not be necessary to define your own macro if all that is needed is a small addition to an existing element that is defined in an enclosing [] block. After the element arguments are expanded, one argument beyond the normal list is automatically expanded before exiting the block, as mentioned near the beginning of [Section 6](#). This extra argument can be used to embellish the element.

A macro is defined using quoted name and replacement text as follows:

```
define('name', 'replacement text')
```

After this line is read by the m4 processor, then whenever `name` is encountered as a separate string, it is replaced by its replacement text, which may have multiple lines. The quotation characters are used to defer macro expansion. Macro arguments are referenced inside a macro by number; thus `$1` refers to the first argument. A few examples will be given.

Example 1: Custom two-terminal elements can often be defined by writing a wrapper for an existing element. For example, an enclosed thermal switch can be defined as shown in [Figure 64](#).

```
define('thermalsw',
'dswitch('$1', '$2', WDdBTh)
circle rad distance(M4T, last line.c) at last line.c')
```

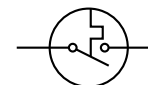

Figure 64: A custom thermal switch defined from the `dswitch` macro.

Example 2: In the following, two macros are defined to simplify the repeated drawing of a series resistor and series inductor, and the macro `tsection` defines a subcircuit that is replicated several times to generate [Figure 65](#).

```
.PS
# 'Tline.m4'
cct_init
hgt = elen_*1.5
ewd = dimen_*0.9
define('sresistor', 'resistor(right_ ewd); llabel(,r)')
define('sinductor', 'inductor(right_ ewd,W); llabel(,L)')
define('tsection', 'sinductor
{ dot; line down_ hgt*0.25; dot
parallel_('resistor(down_ hgt*0.5); rlabel(,R)',
```

```

        'capacitor(down_hgt*0.5); rlabel(C)')
    dot; line down_hgt*0.25; dot }
sresistor ')

SW: Here
gap(up_hgt)
sresistor
for i=1 to 4 do { tsection }
line dotted right_dimen_/2
tsection
gap(down_hgt)
line to SW
.PE

```

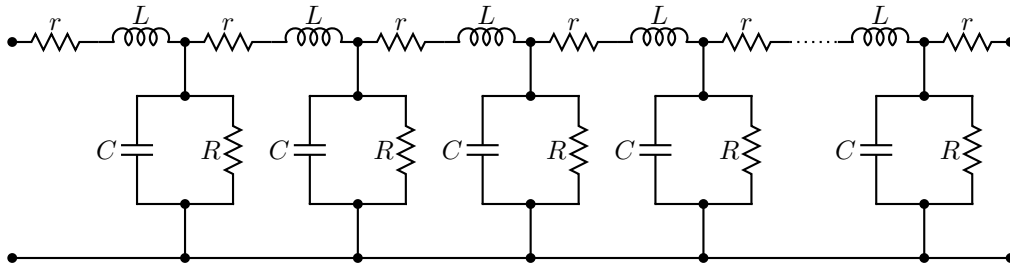

Figure 65: A lumped model of a transmission line, illustrating the use of custom macros.

Example 3: Figure 66 shows an element that is composed of several basic elements and that can be drawn in any direction prespecified by `Point_(degrees)`. The labels always appear in their natural horizontal orientation. Two flags in the argument determine the circuit orientation with respect to

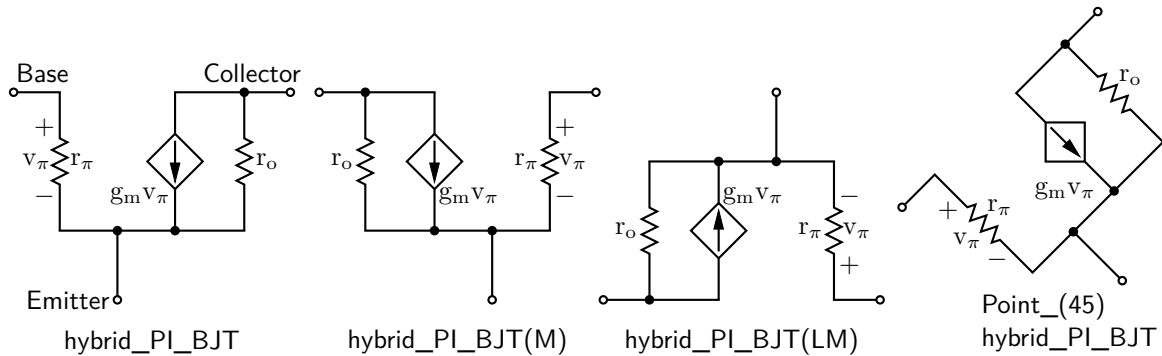

Figure 66: A composite element containing several basic elements

the current drawing direction and whether a mirrored circuit is drawn. The key to writing such a macro is to observe that the pic language allows two-terminal elements to change the current drawing direction, so the value of `rp_ang` should be saved and restored as necessary after each internal two-terminal element has been drawn. A draft of such a macro follows:

```

#                               'Point_(degrees)
#                               hybrid_PI_BJT([L][M])
#                               L=left orientation; M=mirror'
define('hybrid_PI_BJT',
'[                               # Size (and direction) parameters:
    hunit = ifinstr('$1',M,-)dimen_
    vunit = ifinstr('$1',L,-)dimen_*3/2
    hp_ang = rp_ang             # Save the reference direction

```

```

Rpi: resistor(to rvec_(0,-vunit)); point_(hp_ang) # Restore direction
DotG: dot(at rvec_(hunit*5/4,0))
Gm: consource(to rvec_(0,vunit),I,R); point_(hp_ang) # Restore direction
dot(at rvec_(hunit*3/4,0))
Ro: resistor(to rvec_(0,-vunit)); point_(hp_ang) # Restore direction
line from Rpi.start to Rpi.start+vec_(-hunit/2,0) chop -lthick/2 chop 0
Base: dot(,1)
line from Gm.end to Ro.start+vec_(hunit/2,0) chop -lthick/2 chop 0
Collector: dot(,1)
line from Rpi.end to Ro.end chop -lthick/2
DotE: dot(at 0.5 between Rpi.end and DotG)
line to rvec_(0,-vunit/2)
Emitter: dot(,1)

# Labels
"$\mathrm{r\_pi}$" at Rpi.c+vec_(hunit/4,0)
"$ + $" at Rpi.c+vec_(-hunit/6, vunit/4)
"$ - $" at Rpi.c+vec_(-hunit/6,-vunit/4)
"$\mathrm{v\_pi}$" at Rpi.c+vec_(-hunit/4,0)
"$\mathrm{g\_m}$" at Gm.c+vec_(-hunit*3/8,-vunit/4)
"$\mathrm{r\_o}$" at Ro.c+vec_(hunit/4,0)
'$2' ] ')

```

Example 4: A number of elements have arguments meant explicitly for customization. Figure 67 customizes the source macro to show a cycle of a horizontal sinusoid with adjustable phase given by argument 2 in degrees, as might be wanted for a 3-phase circuit:

```

define('phsource','source($1,
#Set angle to 0, draw sinusoid, restore angle'
m4smp_ang = rp_ang; rp_ang = 0
sinusoid(m4h/2,twopi/(m4h),
ifelse('$2',,('$2)/360*twopi+')pi_/2,-m4h/2,m4h/2) with .Origin at Here
rp_ang = m4smp_ang,
$3,$4,$5)')

```

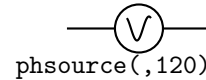

Figure 67: A source element customized using its second argument.

Example 5: Repeated subcircuits might appear only as the subcircuit and its mirror image, for example, so the power of the vec_() and rvec_() macros is not required. Suppose that an optoisolator is to be drawn with left-right or right-left orientation as shown in Figure 68.

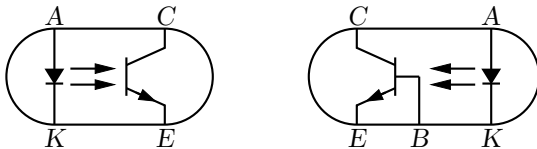

Figure 68: Showing opto and opto(BR) with defined labels.

The macro interface could be something like the following:
opto([L|R] [A|B]),

where an R in the argument string signifies a right-left (mirrored) orientation and the element is of either A or B type; that is, there are two related elements that might be drawn in either orientation, for a total of four possibilities. Those who find such an interface to be too cryptic might prefer to invoke the macro as

```
opto(orientation=Rightleft;type=B),
```

which includes semantic sugar surrounding the R and B characters for readability; this usage is made possible by testing the argument string using the `ifinstr()` macro rather than requiring an exact match. A draft of the macro follows, and the file `Optoiso.m4` in the examples directory adds a third type option.

```
#                               'opto([R|L] [A|B])'
define('opto', '[{u = dimen_/2
Q: bi_trans(up u*2,ifinstr('$1',R,R),ifinstr('$1',B,B)CBUE)
E: Q.E; C: Q.C; A:ifinstr('$1',R,Q.e+(u*3/2,u),Q.w+(-u*3/2,u)); K: A-(0,u*2)
  ifinstr('$1',B,line from Q.B to (Q.B,E); B: Here)
D: diode(from A to K)
  arrow from D.c+(0,u/6) to Q.ifinstr('$1',R,e,w)+(0,u/6) chop u/3 chop u/4
  arrow from last arrow.start-(0,u/3) to last arrow.end-(0,u/3)
Enc: box rad u wid abs(C.x-A.x)+u*2 ht u*2 with .c at 0.5 between C and K
'$2' }])')
```

Two instances of this subcircuit are drawn and placed by the following code, with the result shown in [Figure 68](#).

```
Q1: opto
Q2: opto(type=B;orientation=Rightleft) with .w at Q1.e+(dimen_,0)
```

12.1 Macro arguments

Macro parameters are defined by entering them into specific arguments, and if an argument is blank then a default parameter is used. For the resistor macro, for example:

```
resistor( linespec, cycles, chars, cycle wid );
```

an integer (3, say) in the second argument specifies the number of cycles. Arguments could be entered in a key–value style (for example, `resistor(up_elen_,style=N;cycles=8)`) instead of by positional parameters, but it was decided early on to keep macro usage as close as possible to pic conventions.

More recently, a mixed style has been adopted by which some parameters are entered using keys. Two macros assist this process, of which the first is

```
setkey_(string, key, default value, [N])
```

The first argument is taken to be a sequence of semicolon (;)-separated terms of the form `key=value`; . Then for example in a macro, the line

```
setkey_( '$2', width, dimen_*2 )
```

checks argument 2 for a term `width=value` and defines the macro `m4width` to evaluate to `(dimen_*2)` if not found, otherwise to `(value)`. The enclosing parentheses are omitted if the third argument of `setkey_` is N, as would be required if `m4width` were to be non-numeric.

In addition, the macro

```
setkeys_(string, keysequence)
```

applies `setkey_()` multiple times to its `keysequence` (second) argument. Each term of the second argument consists of the three arguments of `setkey_` separated by the colons (:) rather than commas.

For example, consider the elementary example of a custom box macro:

```
define('custombox',
'setkeys_('$1',width:boxwid;; hgt:boxht;; label::N; text::N)
  ifelse(m4label,,m4label:) box wid m4width ht m4hgt "m4text"')
```

Then `custombox(width=2; label=B1; text>Hello)` first causes the macros `m4width`, `m4hgt`, `m4label`, and `m4text` to be created, with values (2), (boxht), B1, and Hello respectively, and `custombox` evaluates to

```
B1: box wid (2) ht (boxht) "Hello".
```

The key prefix `m4` of the automatically created parameter macros can be redefined if necessary, since it is given in the distribution by the line `define('key_prefix','m4')`.

As another example, the macro `sarrow(linespec, keys)` can generate the custom arrows shown below the three native arrows in Figure 69. The defined keys are `type=`; `lgth=`; `wdth=`; `shaft=`; and `head=`. Many variations of these arrowheads are possible.

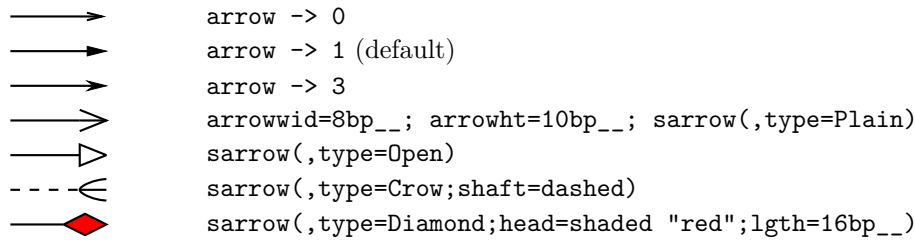

Figure 69: The three dpc native arrows and others generated by `sarrow(linespec, keys)`.

13 Interaction with L^AT_EX

The sizes of typeset labels and other T_EX boxes are generally unknown prior to processing the diagram by L^AT_EX. Although they are not needed for many circuit diagrams, these sizes may be required explicitly for calculations or implicitly for determining the diagram bounding box. The following example shows how text sizes can affect the overall size of a diagram:

```
.PS
B: box
  "Left text" at B.w rjust
  "Right text: $x^2$" at B.e ljust
.PE
```

The pic interpreter cannot know the size of the text to the left and right of the box, and the diagram is generated using default text size values. One solution to this problem is to measure the text sizes by hand and include them literally, thus:

```
"Left text" wid 38.47pt__ ht 7pt__ at B.w rjust
but this is tedious.
```

Often, a better solution is to process the diagram twice. The diagram source is processed as usual by m4 and a pic processor, and the main document source is L^AT_EXed to input the diagram and format the text, and also to write the text dimensions into a supplementary file. Then the diagram source is processed again, reading the required dimensions from the supplementary file and producing a diagram ready for final L^AT_EXing. This hackery is summarized below, with an example in Figure 70.

- Put `\usepackage{boxdims}` into the document source.
- Insert the following at the beginning of the diagram source, where *jobname* is the name of the main L^AT_EX file:

```
sinclude(jobname.dim)
s_init(unique name)
```
- Use the macro `s_box(text)` to produce typeset text of known size, or alternatively, invoke the macros `\boxdims` and `boxdim` described later. The argument of `s_box` need not be text exclusively; it can be anything that produces a T_EX box, for example, `\includegraphics`.

The macro `s_box(text)` evaluates initially to

```
"\boxdims{name}{text}" wid boxdim(name,w) ht boxdim(name,v)
```

On the second pass, this is equivalent to

```
"text" wid x ht y
```

where *x* and *y* are the typeset dimensions of the L^AT_EX input text. If `s_box` is given two or more arguments as in Figure 70 then they are processed by `sprintf`.

```
.PS
gen_init
\include{Circuit_macros.dim}
s_init(stringdims)
B: box
  s_box(Left text) at B.w rjust
  s_box(Right text: $x^2) at B.e ljust
.PE
```

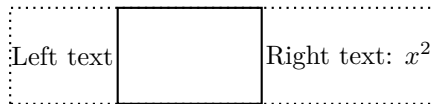

Figure 70: Macro `s_box` sets string dimensions automatically when processed twice. If two or more arguments are given to `s_box`, they are passed through `sprintf`. The bounding box is shown.

The argument of `s_init`, which should be unique within `jobname.dim`, is used to generate a unique `\boxdims` first argument for each invocation of `s_box` in the current file. If `s_init` has been omitted, the symbols “!!” are inserted into the text as a warning. Be sure to quote any commas in the arguments. Since the first argument of `s_box` is \LaTeX source, make a rule of quoting it to avoid comma and name-clash problems. For convenience, the macros `s_ht`, `s_wd`, and `s_dp` evaluate to the dimensions of the most recent `s_box` string or to the dimensions of their argument names, if present.

The file `boxdims.sty` distributed with this package should be installed where \LaTeX can find it. The essential idea is to define a two-argument \LaTeX macro `\boxdims` that writes out definitions for the width, height and depth of its typeset second argument into file `jobname.dim`, where `jobname` is the name of the main source file. The first argument of `\boxdims` is used to construct unique symbolic names for these dimensions. Thus, the line

```
box "\boxdims{Q}{\Huge Hi there!}"
```

has the same effect as

```
box "\Huge Hi there!"
```

except that the line

```
define('Q_w',77.6077pt__)define('Q_h',17.27779pt__)define('Q_d',0.0pt__)dnl
```

is written into file `jobname.dim` (and the numerical values depend on the current font). These definitions are required by the `boxdim` macro described below.

The \LaTeX macro

```
\boxdimfile{dimension file}
```

is used to specify an alternative to `jobname.dim` as the dimension file to be written. This simplifies cases where `jobname` is not known in advance or where an absolute path name is required.

Another simplification is available. Instead of the `\include{dimension file}` line above, the dimension file can be read by `m4` before reprocessing the source for the second time:

```
m4 library files dimension file diagram source file ...
```

Here is a second small example. Suppose that the file `tsbox.m4` contains the following:

```
\documentclass{article}
\usepackage{boxdims,ifpstricks,pstricks,tikz}
\begin{document}
.PS
cct_init s_init(unique) \include{tsbox.dim}
[ source(up,AC); llabel(,s_box(AC supply)) ]; showbox_
.PE
\end{document}
```

The file is processed twice as follows:

```
m4 pgf.m4 tsbox.m4 | dpic -g > tsbox.tex; pdflatex tsbox
```

```
m4 pgf.m4 tsbox.m4 | dpic -g > tsbox.tex; pdflatex tsbox
```

The first command line produces a file `tsbox.pdf` with incorrect bounding box. The second command reads the data in `tsbox.dim` to size the label correctly. The equivalent `pstricks` commands (note the `ifpstricks` macro in the second line of the diagram source) are

```
m4 pstricks.m4 tsbox.m4 | dpic -p > tsbox.tex; latex tsbox
```



```
m4 pstricks.m4 tsbox.m4 | dpic -p > tsbox.tex; latex tsbox; dvips tsbox
```

Objects can be tailored to their attached text by invoking `\boxdims` and `boxdim` explicitly. The small source file in [Figure 71](#), for example, produces the box in the figure.

```
.PS
# 'eboxdims.m4'
\sinclude(Circuit_macros.dim) # The input file is Circuit_macros.tex
\box fill_(0.9) wid \boxdim(Q,w) + 5pt__ ht \boxdim(Q,v) + 5pt__ \
"\boxdims{Q}{\large$\displaystyle\int_0^T e^{tA}\,dt$}"
.PE
```

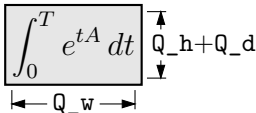

Figure 71: Fitting a box to typeset text.

The figure is processed twice, as described previously. The line `\sinclude(jobname.dim)` reads the named file if it exists. The macro `boxdim(name,suffix,default)` from `libgen.m4` expands the expression `boxdim(Q,w)` to the value of `Q_w` if it is defined, else to its third argument if defined, else to 0, the latter two cases applying if `jobname.dim` doesn't exist yet. The values of `boxdim(Q,h)` and `boxdim(Q,d)` are similarly defined and, for convenience, `boxdim(Q,v)` evaluates to the sum of these. Macro `pt__` is defined as `*scale/72.27` in `libgen.m4`, to convert points to drawing coordinates.

Sometimes a label needs a plain background in order to blank out previously drawn components overlapped by the label, as shown on the left of [Figure 72](#). The technique illustrated in [Figure 71](#)



Figure 72: Illustrating the `f_box` macro.

is automated by the macro `f_box(boxspecs, label arguments)`. For the special case of only one argument, e.g., `f_box(Wood chips)`, this macro simply overwrites the label on a white box of identical size. Otherwise, the first argument specifies the box characteristics (except for size), and the macro evaluates to

```
\box boxspecs \s_box(label arguments).
```

For example, the result of the following command is shown on the right of [Figure 72](#).

```
f_box(color "lightgray" thickness 2 rad 2pt__,"\huge$n^{%g}$",4-1)
```

More tricks can be played. The example

```
Picture: \s_box('\includegraphics{file.eps}') with .sw at location
```

shows a nice way of including eps graphics in a diagram. The included picture (named `Picture` in the example) has known position and dimensions, which can be used to add vector graphics or text to the picture. To aid in overlaying objects, the macro `boxcoord(object name, x-fraction, y-fraction)` evaluates to a position, with `boxcoord(object name,0,0)` at the lower left corner of the object, and `boxcoord(object name,1,1)` at its upper right.

14 PSTricks and other tricks

This section applies only to a pic processor (`dpic`) that is capable of producing output compatible with `PSTricks`, `Tikz PGF`, or in principle, other graphics postprocessors.

By using `command` lines, or simply by inserting \LaTeX graphics directives along with strings to be formatted, one can mix arbitrary `PSTricks` (or other) commands with `m4` input to create complicated effects.

Some commonly required effects are particularly simple. For example, the rotation of text by `PSTricks` postprocessing is illustrated by the file

```
.PS
# 'Axes.m4'
\arrow right 0.7 "$x$-axis" below
\arrow up 0.7 from 1st \arrow.start "\rput[B]{90}(0,0){$y$-axis}" rjust
.PE
```

which contains both horizontal text and text rotated 90° along the vertical line. This rotation of text is also implemented by the macro `rs_box`, which is similar to `s_box` but rotates its argument by 90°, a default angle that can be changed by preceding invocation with `define('text_ang',degrees)`. The `rs_box` macro requires either PSTricks or Tikz PGF and, like `s_box`, it calculates the size of the resulting text box but requires the diagram to be processed twice.

Another common requirement is the filling of arbitrary shapes, as illustrated by the following lines within a `.m4` file:

```
command "\pscustom[fillstyle=solid,fillcolor=lightgray]{'"
drawing commands for an arbitrary closed curve
command "'}%"
```

For colour printing or viewing, arbitrary colours can be chosen, as described in the PSTricks manual. PSTricks parameters can be set by inserting the line

```
command "\psset{option=value, ...}'"
```

in the drawing commands or by using the macro `psset_(PSTricks options)`.

The macros `shade(gray value,closed line specs)` and `rgbfill(red value, green value, blue value, closed line specs)` can be invoked to accomplish the same effect as the above fill example, but are not confined to use only with PSTricks.

Since arbitrary L^AT_EX can be output, either in ordinary strings or by use of `command` output, complex examples such as found in reference [3], for example, can be included. The complications are twofold: L^AT_EX and `dpic` may not know the dimensions of the formatted result, and the code is generally unique to the postprocessor. Where postprocessors are capable of equivalent results, then macros such as `rs_box`, `shade`, and `rgbfill` mentioned previously can be used to hide code differences.

14.1 Tikz with pic

Arbitrary `pic` output can be inserted into a `\tikzpicture` environment. The trick is to keep the `pic` and `Tikz` coordinate systems the same. The lines

```
\begin{tikzpicture}[scale=2.54]
\end{tikzpicture}%
```

in the `dpic -g` output must be changed to

```
\begin{scope}[scale=2.54]
\end{scope}%
```

This is accomplished, for example, by adapting the `\mtotex` macro of Section 2.1.4 as follows:

```
\newcommand\mtotikz[1]{\immediate\write18{m4 pgf.m4 #1.m4 | dpic -g
| sed -e "/begin{tikzpicture}/s/tikzpicture/scope/"
-e "/end{tikzpicture}/s/tikzpicture/scope/" > #1.tex}\input{./#1.tex}}%
```

Then, from within a `Tikz` picture, `\mtotikz{filename}` will create `filename.tex` from `filename.m4` and read the result into the `Tikz` code.

In addition, the `Tikz` code may need to refer to nodes defined in the `pic` diagram. The included `m4` macro `tikznode(tikz node name,[position],[string])` defines a zero-size `Tikz` node at the given `pic` position, which is `Here` by default. This macro must be invoked in the outermost scope of a `pic` diagram, and the `.PS value` scaling construct may not be used.

15 Web documents, pdf, and alternative output formats

Circuit diagrams contain graphics and symbols, and the issues related to web publishing are similar to those for other mathematical documents. Here the important factor is that `gpic -t` generates output containing `tpic \special` commands, which must be converted to the desired output, whereas `dpic` can generate several alternative formats, as shown in Figure 73. One of the easiest methods for

producing web documents is to generate postscript as usual and to convert the result to pdf format with Adobe Distiller or equivalent.

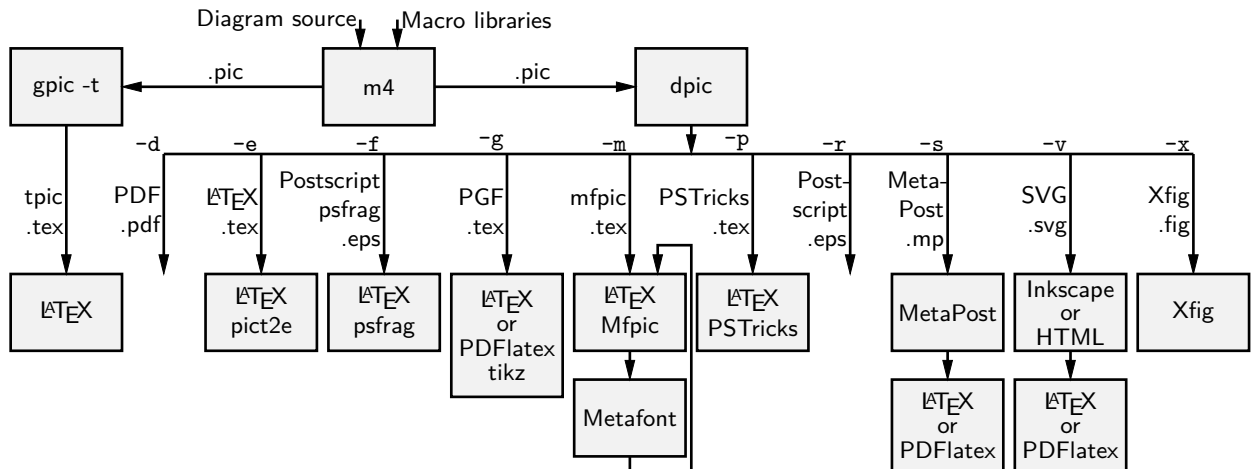

Figure 73: Output formats produced by `gpict-t` and `dpic`. SVG output can be read by Inkscape or used directly in web documents.

PDFLatex produces pdf without first creating a postscript file but does not handle `tpic \specials`, so `dpic` must be installed.

Most PDFLatex distributions are not directly compatible with PSTricks, but the Tikz PGF output of `dpic` is compatible with both L^AT_EX and PDFLatex. Several alternative `dpic` output formats such as `mfpic` and `MetaPost` also work well. To test `MetaPost`, create a file `filename.mp` containing appropriate header lines, for example:

```
verbatimtex
\documentclass[11pt]{article}
\usepackage{times,boxdims,graphicx}
\boxdimfile{tmp.dim}
\begin{document} etex
```

Then append one or more diagrams by using the equivalent of

```
m4 <installdir>mpost.m4 library files diagram.m4 | dpic -s > filename.mp
```

The command “`mpost -tex=latex filename.mp end`” processes this file, formatting the diagram text by creating a temporary `.tex` file, L^AT_EXing it, and recovering the `.dvi` output to create `filename.1` and other files. If the `boxdims` macros are being invoked, this process must be repeated to handle formatted text correctly as described in [Section 13](#). In this case, either put `\sinclude{tmp.dim}` in the diagram `.m4` source or read the `.dim` file at the second invocation of `m4` as follows:

```
m4 <installdir>mpost.m4 library files tmp.dim diagram.m4 | dpic -s > filename.mp
```

On some operating systems, the absolute path name for `tmp.dim` has to be used to ensure that the correct dimension file is written and read. This distribution includes a `Makefile` that simplifies the process; otherwise a script can automate it.

Having produced `filename.1`, rename it to `filename.mps` and, *voilà*, you can now run PDFLatex on a `.tex` source that includes the diagram using `\includegraphics{filename.mps}` as usual.

The `dpic` processor can generate other output formats, as illustrated in [Figure 73](#) and in example files included with the distribution. The L^AT_EX drawing commands alone or with `eeepic` or `pict2e` extensions are suitable only for simple diagrams.

16 Developer’s notes

Years ago in the course of writing a book, I took a few days off to write a `pic`-like interpreter (`dpic`) to automate the tedious coordinate calculations required by L^AT_EX picture objects. The macros in

this distribution and the interpreter are the result of that effort, drawings I have had to produce since, and suggestions received from others. The interpreter has been upgraded over time to generate mfpic, MetaPost [5], raw Postscript, Postscript with `psfrag` tags, raw PDF, PSTricks, and TikZ PGF output, the latter two my preference because of their quality and flexibility, including facilities for colour and rotations, together with simple font selection. Xfig-compatible output was introduced early on to allow the creation of diagrams both by programming and by interactive graphics. SVG output was added relatively recently, and seems suitable for producing web diagrams directly and for further editing by the Inkscape interactive graphics editor. The latest addition is raw PDF output, which has very basic text capability and is most suitable for creating diagrams without labels, but on which sophisticated text can be overlaid if necessary. Dpic can write the coordinates of selected locations to an external file to be used in overlaying text or other items on the diagram.

The main value of this distribution is not intended to be in the use of a specific language but in the element data encoded in the macros, which have been developed with reference to standards and refined over more than two decades, and which now total thousands of lines. Some of the macros have become less readable as more options and flexibility have been added, and if starting over today, perhaps I would change some details. Compromises have been made in order to retain reasonable compatibility with the variety of postprocessors. No choice of tool is without compromise, and producing good graphics seems to be time consuming, no matter how it is done, especially for circuits or other diagrams that contain random detail.

Instead of using pic macros, I preferred the equally simple but more powerful m4 macro processor, and therefore m4 is required here, although dpic now supports pic-like macros. Free versions of m4 are available for Unix and its descendents, Windows, and other operating systems.

If starting over today would I not just use one of the other drawing packages available these days? It would depend on the context, but pic remains a good choice for line drawings because it is easy to learn and read but powerful enough for coding the geometrical calculations required for precise component sizing and placement. It would be nice if arbitrary rotations and scaling were simpler and if a general path element with clipping were available as in Postscript. However, all the power of Postscript or TikZ PGF, for example, remains available, as arbitrary postprocessor code can be included with pic code.

The dpic interpreter has several output-format options that may be useful. The `eepicemu` and `pict2e` extensions of the primitive L^AT_EX picture objects are supported. The mfpic output allows the production of Metafont alphabets of circuit elements or other graphics, thereby essentially removing dependence on device drivers, but with the complication of treating every alphabetic component as a T_EX box. The xfig output allows elements to be precisely defined with dpic and interactively placed with xfig. Similarly, the SVG output can be read directly by the Inkscape graphics editor, but SVG can also be used directly for web pages. Dpic will also generate low-level MetaPost or Postscript code, so that diagrams defined using pic can be manipulated and combined with others. The Postscript output can be imported into CorelDraw and Adobe Illustrator for further processing. With raw Postscript, PDF, and SVG output, the user is responsible for ensuring that the correct fonts are provided and for formatting the text.

Many thanks to the people who continue to send comments, questions, and, occasionally, bug fixes. What began as a tool for my own use changed into a hobby that has persisted, thanks to your help and advice.

17 Bugs

This section provides hints and a list of common errors.

The distributed macros are not written for maximum robustness. Macro arguments could be tested for correctness and explanatory error messages could be written as necessary, but that would make the macros more difficult to read and to write. You will have to read them when unexpected results are obtained or when you wish to modify them.

Maintaining reasonable compatibility with both gpic and dpic and, especially, with different postprocessors, has resulted in some macros becoming more complicated than is preferable.

Here are some hints, gleaned from experience and from comments I have received.

1. **Misconfiguration:** One of the configuration files listed in [Section 2.2](#) and `libgen.m4` *must* be read by m4 before any other library macros. Otherwise, the macros assume default configuration. To aid in detecting the default condition, a `WARNING` comment line is inserted into the `pic` output. If only PSTricks is to be used, for example, then the simplest strategy is to set it as the default processor by typing “make psdefault” in the installation directory to change the mention of `gpic` to `pstricks` near the top of `libgen.m4`. Similarly if only Tikz PGF will be used, change `gpic` to `pgf` using the Makefile. The package default is to read `gpic.m4` for historical compatibility. The processor options must be chosen correspondingly, `gpic -t` for `gpic.m4` and, most often, `dpic -p` or `dpic -g` when `dpic` is employed. For example, the pipeline for PSTricks output from file `quick.m4` is

```
m4 -I installdir pstricks.m4 quick.m4 | dpic -p > quick.tex
```

but for Tikz PGF processing, the configuration file and `dpic` option have to be changed:

```
m4 -I installdir pgf.m4 quick.m4 | dpic -g > quick.tex
```

Any non-default configuration file must appear explicitly in the command line or in an `include()` statement.

2. **Pic objects versus macros:** A common error is to write something like

```
line from A to B; resistor from B to C; ground at D
```

when it should be

```
line from A to B; resistor(from B to C); ground(at D)
```

This error is caused by an unfortunate inconsistency between `pic` object attributes and the way m4 and `pic` pass macro arguments.

3. **Commas:** Macro arguments are separated by commas, so any comma that is part of an argument must be protected by parentheses or quotes. Thus,

```
shadexbox(box with .n at w,h)
```

produces an error, whereas

```
shadexbox(box with .n at w', 'h)
```

and

```
shadexbox(box with .n at (w,h))
```

do not. The parentheses are preferred. For example, a macro invoked by circuit elements contained the line

```
command "\pscustom[fillstyle=solid', 'fillcolor=m4fillv]{%"
```

which includes a comma, duly quoted. However, if such an element is an argument of another macro, the quotes are removed and the comma causes obscure “too many arguments” error messages. Changing this line to

```
command sprintf("\pscustom[fillstyle=solid,fillcolor=m4fillv]{%")
```

cured the problem because the protecting parentheses are not stripped away.

4. **Default directions and lengths:** The `linespec` argument of element macros defines a straight-line segment, which requires the equivalent of four parameters to be specified uniquely. If information is omitted, default values are used. Writing

```
source(up_)
```

draws a source from the current position up a distance equal to the current `lineht` value, which may cause confusion. Writing

```
source(0.5)
```

draws a source of length 0.5 units in the current `pic` default direction, which is one of `right`, `left`, `up`, or `down`. The best practice is to specify both the direction and length of an element, thus:

```
source(up_elen_).
```

The effect of a *linespec* argument is independent of any direction set using the `Point_` or similar macros. To draw an element at an obtuse angle (see [Section 7](#)) try, for example,
`Point_(45); source(to rvec_(0.5,0))`

5. **Processing sequence:** It is easy to forget that m4 finishes before pic processing begins. Consequently, it may be puzzling that the following mix of a pic loop and the m4 macro `s_box` does not appear to produce the required result:

```
for i=1 to 5 do {s_box(A[i]); move }
```

In this example, the `s_box` macro is expanded only once and the index `i` is not a number. This particular example can be repaired by using an m4 loop:

```
for_(1,5,1, 's_box(A[m4x]); move')
```

Note that the loop index variable `m4x` is automatically defined.

6. **Quotes:** Single quote characters are stripped in pairs by m4, so the string

```
"'inverse'"
```

will become

```
"'inverse'".
```

The cure is to add single quotes in pairs as necessary.

The only subtlety required in writing m4 macros is deciding when to quote macro arguments. In the context of circuits it seemed best to assume that arguments would not be protected by quotes at the level of macro invocation, but should be quoted inside each macro. There may be cases where this rule is not optimal or where the quotes could be omitted, and there are rare exceptions such as the `parallel_` macro.

To keep track of paired single quotes, parentheses “(,),” braces “{, },” and brackets “[,],” use an editor that highlights these pairs. For example, the vim editor highlights single quotes with the command `:set mps+=‘:’`.

7. **Dollar signs:** The i -th argument of an m4 macro is $\$i$, where i is an integer, so the following construction can cause an error when it is part of a macro,

```
"$0$" rjust below
```

since `$0` expands to the name of the macro itself. To avoid this problem, put the string in quotes or write `"$'0$"`.

8. **Name conflicts:** Using the name of a macro as part of a comment or string is a simple and common error. Thus,

```
arrow right "$\dot x$" above
```

produces an error message because `dot` is a macro name. Macro expansion can be avoided by adding quotes, as follows:

```
arrow right "'$\dot x$'" above
```

Library macros intended only for internal use have names that begin with `m4` or `M4` to avoid name clashes, but in addition, a good rule is to quote all L^AT_EX in the diagram input.

If extensive use of strings that conflict with macro names is required, then one possibility is to replace the strings by macros to be expanded by L^AT_EX, for example the diagram

```
.PS
  box "\stringA"
.PE
```

with the L^AT_EX macro

```
\newcommand{\stringA}{
```

```
Circuit containing planar inductor and capacitor}
```

9. **Current direction:** Some macros, particularly those for labels, do unexpected things if care is not taken to preset the current direction using macros `right_`, `left_`, `up_`, `down_`, or `rpoint_(·)`. Thus for two-terminal macros it is good practice to write, e.g.

```
resistor(up_ from A to B); rlabel(,R_1)
```

rather than

```
resistor(from A to B); rlabel(,R_1),
```

which produce different results if the last-defined drawing direction is not up. It might be possible to change the label macros to avoid this problem without sacrificing ease of use.

10. **Position of elements that are not 2-terminal:** The *linespec* argument of elements defined in [] blocks must be understood as defining a direction and length, but not the position of the resulting block. In the pic language, objects inside these brackets are placed by default *as if the block were a box*. Place the element by its compass corners or defined interior points as described in the first paragraph of [Section 6](#) on [page 18](#), for example

```
igbt(up_ elen_) with .E at (1,0)
```

11. **Pic error messages:** Some errors are detected only after scanning beyond the end of the line containing the error. The semicolon is a logical line end, so putting a semicolon at the end of lines may assist in locating bugs.
12. **Line continuation:** A line is continued to the next if the rightmost character is a backslash or, with `dpic`, if the backslash is followed immediately by the `#` character. A blank after the backslash, for example, produces a pic error.
13. **Scaling:** Pic and these macros provide several ways to scale diagrams and elements within them, but subtle unanticipated effects may appear. The line `.PS x` provides a convenient way to force the finished diagram to width `x`. However, if `gpic` is the pic processor then all scaled parameters are affected, including those for arrowheads and text parameters, which may not be the desired result. A good general rule is to use the `scale` parameter for global scaling unless the primary objective is to specify overall dimensions.
14. **Buffer overflow:** For some m4 implementations, the error message `pushed back more than 4096 chars` results from expanding large macros or macro arguments, and can be avoided by enlarging the buffer. For example, the option `-B16000` enlarges the buffer size to 16000 bytes. However, this error message could also result from a syntax error.
15. **PSTricks anomaly:** If you are using PSTricks and you get the error message `Graphics parameter 'noCurrentPoint' not defined..` then your version of PSTricks is older than August 2010. You can do the following:
- Update your PSTricks package.
 - Instead, comment out the second definition of `M4PatchPSTricks` in `pstricks.m4`. The first definition works for some older PSTricks distributions.
 - Insert `define('M4PatchPSTricks',)` immediately after the `.PS` line of your diagram. This change prevents the line `\psset{noCurrentPoint}` from being added to the `.tex` code for the diagram. This line is a workaround for a “feature” of the current PSTricks `\psbezier` command that changes its behaviour within the `\pscustom` environment. This situation occurs rarely and so the line is unnecessary for many diagrams.
 - For very old versions of PSTricks such as `pstricks97`, disable the workaround totally by changing the second definition in `pstricks.m4` to `define('M4PatchPSTricks',)`. Undo the change if you later update PSTricks.
16. **m4 -I error:** Some old versions of m4 may not implement the `-I` option or the `M4PATH` environment variable that simplify file inclusion. The simplest course of action is probably to install GNU m4, which is free and widely available. Otherwise, all `include(filename)`

statements in the libraries and calling commands have to be given absolute *filename* paths. You can define the `HOMELIB_` macro in `libgen.m4` to the path of the installation directory and change the library include statements to the form `include(HOMELIB_ 'filename)`.

18 List of macros

The following table lists macros in the libraries, configuration files, and selected macros from example diagrams. Some of the sources in the `examples` directory contain additional macros, such as for flowcharts, Boolean logic, and binary trees.

Internal macros defined within the libraries begin with the characters `m4` or `M4` and, for the most part, are not listed here.

The library in which each macro is found is given, and a brief description.

A B C D E F G H I J K L M N O P R S T U V W X Y

A	<code>above_</code>	gen	string position above relative to current direction
	<code>abs_(number)</code>	gen	absolute value function
	<code>ACsymbol(at position, len, ht, [A]U D L R degrees)</code>	cct	draw an AC symbol (1-cycle sine wave); If arg 4 contains A, two arcs are drawn. The current drawing direction is default, otherwise Up, Down, Left, Right, or at <i>degrees</i> slant; (Section 4.2) e.g., <code>ebox; {ACsymbol(at last [],,dimen_/8)}</code>
	<code>adc(width,height,nIn,nN,nOut,nS)</code>	cct	ADC with defined width, height, and number of inputs <i>In_i</i> , top terminals <i>N_i</i> , outputs <i>Out_i</i> , and bottom terminals <i>S_i</i>
	<code>addtaps[arrowhd type=arrowhd;name=Name], fraction, length, fraction, length, ...)</code>	cct	Add taps to the previous two-terminal element. <i>arrowhd</i> = blank or one of . - <- -> <->. Each fraction determines the position along the element body of the tap. A negative length draws the tap to the right of the current direction; positive length to the left. Tap names are Tap1, Tap2, ... by default or Name1, Name2, ... if specified (Section 6)
	<code>along_(linear object name)</code>	gen	short for <code>between name.start</code> and <code>name.end</code>
	<code>Along_(LinearObj,distance,[R])</code>	gen	Position arg2 (default all the way) along a linear object from <code>.start</code> to <code>.end</code> (from <code>.end</code> to <code>.start</code> if arg3=R)
	<code>amp(linespec,size)</code>	cct	amplifier (Section 4.2)
	<code>And, Or, Not, Nand, Nor, Xor, Nxor, Buffer</code>	log	Wrappers of <code>AND_gate</code> , ... for use in the <code>Autologix</code> macro
	<code>AND_gate(n,N)</code>	log	basic 'and' gate, 2 or <i>n</i> inputs; N=negated input. Otherwise, arg1 can be a sequence of letters P N to define normal or negated inputs (Section 9)
	<code>AND_gen(n,chars,[wid,[ht]])</code>	log	general AND gate: <i>n</i> =number of inputs ($0 \leq n \leq 16$); <i>chars</i> : B=base and straight sides; A=Arc; [N]NE,[N]SE,[N]I,[N]N,[N]S=inputs or circles; [N]O=output; C=center. Otherwise, arg1 can be a sequence of letters P N to define normal or negated inputs.
	<code>AND_ht</code>	log	height of basic 'and' and 'or' gates in <code>L_units</code>
	<code>AND_wd</code>	log	width of basic 'and' and 'or' gates in <code>L_units</code>

antenna(*at location*, T, A|L|T|S|D|P|F, U|D|L|R|degrees)
 cct antenna, without stem for nonblank 2nd arg; A=aerial, L=loop, T=triangle, S=diamond, D=dipole, P=phased, F=fork; up, down, left, right, or angle from horizontal (default 90) (Section 6)

arca(*absolute chord linespec*, ccw|cw, *radius*, *modifiers*)
 gen arc with acute angle (obtuse if radius is negative), drawn in a [] block

ArcAngle(*position*, *position*, *position*, *radius*, *modifiers*, *label*)
 gen Arc angle symbol drawn ccw at arg2. Arg4 is the radius from arg2; arg5 contains line attributes, e.g., **thick** **linethick/2 ->**; arg6 is an optional label at mid-arc

arcd(*center*, *radius*,*start degrees*,*end degrees*)
 gen Arc definition (see **arcr**), angles in degrees (Section 3.3)

arcdimension_(*arcspec*,*offset*,*label*, D|H|W| *blank width*,*tic offset*,*arrowhead*)
 gen like **dimension_**, for drawing arcs for dimensioning diagrams; *arrowhead*==> | <-. Uses the first argument as the attributes of an invisible arc: **arc invis arg1**. Arg2 is the radial displacement (possibly negative) of the dimension arrows. If *arg3* is **s_box(...)** or **rs_box(...)** and *arg4*=D|H|W then *arg4* means: D: blank width is the diagonal length of *arg3*; H: blank width is the height of *arg3* + **textoffset*2**; W: blank width is the width of *arg3* + **textoffset*2**; otherwise *arg4* is the absolute blank width

arcr(*center*,*radius*,*start angle*,*end angle*,*modifiers*,*ht*)
 gen Arc definition. If arg5 contains <- or -> then a midpoint arrowhead of height equal to arg6 is added. Arg5 can contain modifiers (e.g. outlined "red"), for the arc and arrowhead. Modifiers following the macro affect the arc only, e.g., **arcr(A,r,0,pi_/2,->) dotted ->** (Section 3.3)

arcto(*position 1*,*position 2*,*radius*, [*dashed*|*dotted*])
 gen line toward position 1 with rounded corner toward position 2

arrester(*linespec*,*chars*, *len*[:**arrowhead ht**], *ht*[:**arrowhead wid**])
 cct Arg2 *chars*: G= spark gap (default), g= general (dots), E= gas discharge, S= box enclosure, C= carbon block, A= electrolytic cell, H= horn gap, P= protective gap, s= sphere gap, F= film element, M= multigap. *Modifiers in arg2*: R= right orientation, L= left orientation, D= 3-terminal element for S, E only, with terminals A, B, G (Section 4.2)

arrowline(*linespec*)
 cct line (dotted, dashed permissible) with centred arrowhead (Section 4.2)

AutoGate
 log Draw the tree for a gate as in the **Autologix** macro. No inputs or external connections are drawn. The names of the internal gate inputs are stacked in 'AutoInNames'

assign3(*var name*,*var name*,*var name*,*arg4*,*arg5*,*arg6*)
 gen Assigns \$1 = arg4 if \$1 is nonblank; similarly \$2 = arg5 and \$3 = arg6

Autologix(*Boolean function sequence*, [N[**oconnect**]] [L[**leftinputs**]] [R] [V] [M] [; **offset=value**]

	log	Draw the Boolean expressions defined in function notation using And , Or , Not , Buffer , Xor , Nand , Nor , Nxor and variables, e.g., Autologix(And(Or(x1, x2),Or(x1,x2))) ; The Boolean functions are separated by semicolons (;). Function outputs are aligned vertically but appending <i>:location attribute</i> to a function can be used to place it. Each unique variable <i>var</i> causes an input point <i>Invar</i> to be defined. Preceding the variable by a \sim causes a not gate to be drawn at the input. The inputs are drawn in a row at the upper left by default. An L in <i>arg2</i> draws the inputs in a column at the left; R reverses the order of the drawn inputs; V scans the expression from right to left when listing inputs; M draws the left-right mirror image of the diagram; and N draws only the function tree without the input array. The inputs are labelled In1 , In2 , ... and the function outputs are Out1 , Out2 , ... Each variable <i>var</i> corresponds also to one of the input array points with label <i>Invar</i> . Setting offset=value displaces the drawn input list in order to disambiguate the input connections when L is used	
B	b_	gen	blue color value
	b_current (<i>label, pos, In Out, Start End, frac</i>)	cct	labelled branch-current arrow to <i>frac</i> between branch end and body (Section 4.3)
	basename_ (<i>string sequence, separator</i>)	gen	Extract the rightmost name from a sequence of names separated by <i>arg2</i> (default dot ".")
	battery (<i>linespec, n, R</i>)	cct	n-cell battery: default 1 cell, R =reversed polarity (Section 4.2)
	beginshade (<i>gray value</i>)	gen	begin gray shading, see shade e.g., beginshade(.5) ; <i>closed line specs</i> ; endshade
	bell (U D L R degrees, size)	cct	bell, <i>In1</i> to <i>In3</i> defined (Section 6)
	below_	gen	string position relative to current direction
	bi_tr (<i>linespec, L R, P, E</i>)	cct	left or right, N- or P-type bipolar transistor, without or with envelope (Section 6.1)
	bi_trans (<i>linespec, L R, chars, E</i>)	cct	bipolar transistor, core left or right; chars : BU =bulk line, B =base line and label, S =Schottky base hooks, uEn dEn =emitters E0 to En , uE dE =single emitter, Cn uCn dCn =collectors C0 to Cn ; u or d add an arrow, C =single collector; u or d add an arrow, G =gate line and location, H =gate line; L =L-gate line and location, [d]D =named parallel diode, d =dotted connection, [u]T =thyristor trigger line; <i>arg 4 = E</i> : envelope (Section 6.1)
	binary_ (<i>n, [m]</i>)	gen	binary representation of <i>n</i> , left padded to <i>m</i> digits if the second argument is nonblank
	BOX_gate (<i>inputs, output, swid, sht, label</i>)	log	output= [P N] , inputs= [P N] ... , sizes swid and sht in L_units (default AND_wd = 7) (Section 9)
	boxcoord (<i>planar obj, x fraction, y fraction</i>)	gen	internal point in a planar object

	<code>boxdim(name,h w d v,default)</code>	gen	evaluate, e.g. <code>name_w</code> if defined, else <code>default</code> if given, else 0 <code>v</code> gives sum of <code>d</code> and <code>h</code> values (Section 13)
	<code>bp__</code>	gen	big-point-size factor, in scaled inches, (<code>*scale/72</code>)
	<code>bswitch(linespec, [L R],chars)</code>	cct	pushbutton switch R=right orientation (default L=left); chars: O= normally open, C=normally closed
	<code>BUF_ht</code>	log	basic buffer gate height in L_units
	<code>BUF_wd</code>	log	basic buffer gate width in L_units
	<code>BUFFER_gate(linespec, [N B], wid, ht, [N P]*, [N P]*, [N P]*)</code>	log	basic buffer, default 1 input or as a 2-terminal element, arg2: N=negated input, B=box gate; arg 5: normal (P) or negated N) inputs labeled In1 (Section 9)
	<code>BUFFER_gen(chars,wd,ht, [N P]*, [N P]*, [N P]*)</code>	log	general buffer, chars: T=triangle, [N]O=output location Out (NO draws circle N_Out); [N]I, [N]N, [N]S, [N]NE, [N]SE input locations; C=centre location. Args 4-6 allow alternative definitions of respective In, NE, and SE argument sequences
	<code>buzzer(U D L R degrees, size,[C])</code>	cct	buzzer, In1 to In3 defined, C=curved (Section 6)
C	<code>c_fet(linespec,R,P)</code>	cct	left or right, plain or negated pin simplified MOSFET
	<code>capacitor(linespec,chars,R, height, wid)</code>	cct	capacitor, chars: F or blank=flat plate; dF flat plate with hatched fill; C=curved-plate; dC=curved-plate with variability arrowhead; CP=constant phase element; E=polarized boxed plates; K=filled boxed plates; M=unfilled boxes; M=one rectangular plate; P=alternate polarized; + adds a polarity sign; +L polarity sign to the left of drawing direction; arg3: R=reversed polarity; arg4 = height (defaults F: <code>dimen_/3</code> , C,P: <code>dimen_/4</code> , E,K: <code>dimen_/5</code>); arg5 = wid (defaults F: <code>height*0.3</code> , C,P: <code>height*0.4</code> , CP: <code>height*0.8</code> , E,K: <code>height</code>) (Section 4.2)
	<code>cbreaker(linespec,L R,D Th TS)</code>	cct	circuit breaker to left or right, D=with dots; Th=thermal; TS=squared thermal (Section 4.2)
	<code>c coax(at location, M F, diameter)</code>	cct	coax connector, M=male, F=female (Section 6)
	<code>cct_init</code>	cct	initialize circuit-diagram environment (reads <code>libcct.m4</code>)
	<code>centerline_(linespec, thickness color, minimum long dash len, short dash len, gap len)</code>	gen	Technical drawing centerline
	<code>Cintersect(Pos1, Pos2, rad1, rad2, [R])</code>	gen	Upper (lower if <code>arg5=R</code>) intersection of circles at <code>Pos1</code> and <code>Pos2</code> , radius <code>rad1</code> and <code>rad2</code>
	<code>clabel(label,label,label,arg4,arg5)</code>	cct	Triple label along the drawing axis of an element in the current direction (Section 4.4). Labels are placed at the beginning, centre, or end of the last <code>[]</code> block (or a named <code>[]</code> block). The labels are treated as math, but copied literally if in double quotes or defined by <code>sprintf</code> . <code>Arg4</code> can be <code>above</code> , <code>below</code> , <code>left</code> , or <code>right</code> to supplement the default position. <code>Arg5</code> is the optional name of a <code>[]</code> block to be labelled and is <code>last []</code> by default

	<code>cm__</code>	gen	absolute centiimetres
	<code>consorce(<i>linespec</i>,V I v i,R)</code>	cct	voltage or current controlled source with alternate forms; R=reversed polarity (Section 4.2)
	<code>contact(<i>chars</i>)</code>	cct	single-pole contact: O= normally open, C= normally closed (default), I= open circle contacts, P= three position, R= right orientation, T= T contacts, U= U contacts (Section 6)
	<code>contacts(<i>count</i>, <i>chars</i>)</code>	cct	multiple ganged single-pole contacts: P= three position, O= normally open, C= normally closed, D= dashed ganging line over contact armatures I= open circle contacts, R= right orientation, T= T contacts, U= U contact lines parallel to drawing direction (Section 6)
	<code>contline(<i>line</i>)</code>	gen	evaluates to continue if processor is dpic , otherwise to first arg (default line)
	<code>corner(<i>line thickness</i>,<i>attributes</i>,<i>turn radians</i>)</code>	gen	Mitre (default filled square) drawn at end of last line or at a given position. arg1 default: current line thickness; arg2: e.g. outlined string ; if arg2 starts with at position then a manhattan (right-left-up-down) corner is drawn; arg3= radians (turn angle, +ve is ccw, default $\pi/2$). The corner is enclosed in braces in order to leave Here unchanged unless arg2 begins with at (Section 7)
	<code>Cos(<i>integer</i>)</code>	gen	cosine function, <i>integer</i> degrees
	<code>cosd(<i>arg</i>)</code>	gen	cosine of an expression in degrees
	<code>Cosine(<i>amplitude</i>, <i>freq</i>, <i>time</i>, <i>phase</i>)</code>	gen	function $a \times \cos(\omega t + \phi)$
	<code>cross(<i>at location</i>)</code>	gen	plots a small cross
	<code>cross3D(<i>x1</i>,<i>y1</i>,<i>z1</i>,<i>x2</i>,<i>y2</i>,<i>z2</i>)</code>	3D	cross product of two triples
	<code>crossover(<i>linespec</i>, L R, <i>Line1</i>, ...)</code>	cct	line jumping left or right over named lines (Section 6.1)
	<code>crosswd_</code>	gen	cross dimension
	<code>csdim_</code>	cct	controlled-source width
D	<code>d_fet(<i>linespec</i>,R,P,E S)</code>	cct	left or right, N or P depletion MOSFET, envelope or simplified (Section 6.1)
	<code>dabove(<i>at location</i>)</code>	darrow	above (displaced $dlinewid/2$)
	<code>dac(<i>width</i>,<i>height</i>,<i>nIn</i>,<i>nN</i>,<i>nOut</i>,<i>nS</i>)</code>	cct	DAC with defined width, height, and number of inputs In_i , top terminals N_i , ouputs Out_i , and bottom terminals Si (Section 9)
	<code>dar(<i>center position</i>, <i>radius</i>, <i>start radians</i>, <i>end radians</i>, <i>dline thickness</i>, <i>arrowhead wid</i>, <i>arrowhead ht</i>, <i>terminals</i>)</code>	darrow	See also Darc . CCW arc in dline style, with closed ends or (dpic only) arrowheads. Permissible <i>terminals</i> : x-, -x, x-x, ->, x->, <-, <-x, <-> where x means or (half-thickness line) !.
	<code>Darc(<i>center position</i>, <i>radius</i>, <i>start radians</i>, <i>end radians</i>, <i>parameters</i>)</code>	darrow	Wrapper for dar . CCW arc in dline style, with closed ends or (dpic only) arrowheads. Semicolon-separated <i>parameters</i> : thick=value , wid=value , ends= x- , -x , x-x , -> , x-> , <- , <-x , <-> where x means or (half-thickness line) !.

Darlington(L|R,chars) cct Composite Darlington pair Q1 and Q2 with internal locations E, B, C; Characters in *arg2*: E= envelope, P= P-type, B1= internal base lead, D= damper diode, R1= Q1 bias resistor; E1= ebox, R2= Q2 bias resistor; E1= ebox, Z= zener bias diode (Section 6.1)

darrow_init darrow initialize darrow drawing parameters (reads **darrow.m4**)

Darrow(linespec, parameters) darrow Wrapper for **darrow**. Semicolon-separated *parameters*: **S**, **E** truncate at start or end by dline thickness/2; **thick=val** (total thicknes, ie width); **wid=val** (arrowhead width); **ht=val** (arrowhead height); **ends= x-x** or **-x** or **x-** where *x* is **!** (half-width line) or **|** (full-width line).

darrow(linespec, t,t,width,arrowhd wd,arrowhd ht,parameters) darrow See also **Darrow**. double arrow, truncated at beginning or end, specified sizes, with arrowhead or closed stem. *parameters= x-* or *->* or *x->* or *<-* or *<-x* or *<->* where *x* is **|** or **!**. The **!-** or **-!** parameters close the stem with half-thickness lines to simplify butting to other objects.

dashline(linespec,thickness|color|<->, dash len, gap len,G) gen dashed line with dash at end (G ends with gap)

dbelow(at location) darrow below (displaced dlinewid/2)

dcosine3D(i,x,y,z) 3D extract i-th entry of triple x,y,z

DCsymbol(at position, len, ht, U|D|L|R|degrees) cct A DC symbol (a dashed line below a solid line). The current drawing direction is default, otherwise Up, Down, Left, Right, or at *degrees* slant; e.g., **source**(up_dimen_); { **DCsymbol**(at last [] ,,R) } (Section 4.2)

delay_rad_ cct delay radius

delay(linespec,size) cct delay element (Section 4.2)

delemnit_ darrow sets drawing direction for dlines

Deltasymbol(at position,keys, U|D|L|R|degrees) (default U for up) cct Delta symbol for power-system diagrams. *keys: size=expression*

Demux(n,label, [L] [B|H|X] [N[n] |S[n]] [[N]OE], wid,ht) log binary multiplexer, *n* inputs, L reverses input pin numbers, B displays binary pin numbers, H displays hexadecimal pin numbers, X do not print pin numbers, N[n] puts Sel or Sel0 .. Sel*n* at the top (i.e., to the left of the drawing direction), S[n] puts the Sel inputs at the bottom (default) OE (N=negated) OE pin (Section 9)

dend(at location) darrow close (or start) double line

dfillcolor darrow dline fill color (default white)

diff_(a,b) gen difference function

diff3D(x1,y1,z1,x2,y2,z2) 3D difference of two triples

dimen_ cct size parameter for scaling circuit element bodies (Section 11.1)

dimension_(linespec,offset,label, D|H|W|blank width,tic offset,arrowhead) gen macro for dimensioning diagrams; *arrowhead=>* | *<-*

diode(linespec,B|CR|D|G|L|LE[R] |P[R] |S|Sh|T|V|v|w|Z|chars, [R] [E])

	cct	diode: B=bi-directional, CR=current regulator, D=diac, G=Gunn, L=open form with centre line, LE[R]=LED [right], P[R]=photodiode [right], S=Schottky, Sh=Shockley, T=tunnel, V=varicap, v=varicap (curved plate), w=varicap (reversed polarity), Z=zener; appending K to arg 2 draws open arrowheads; arg 3: R=reversed polarity, E=enclosure (Section 4.2)
dir_	darrow	used for temporary storage of direction by darrow macros
distance(Position 1, Position2)	gen	distance between named positions
distance(position, position)	gen	distance between positions
dlabel(long,lat,label,label,label,chars)	cct	general triple label; <i>chars</i> : <i>x</i> (drawing direction) displacement is from the centre of the last line rather than the centre of the last []; L,R,A,B align labels ljust, rjust, above, or below (absolute) respectively (Section 4.4)
dleft	darrow	double line left turn
Dline(linespec, parameters)	darrow	Wrapper for <code>dline</code> . Semicolon-separated <i>parameters</i> : S, E truncate at start or end by <code>dline</code> thickness/2; <code>thick=val</code> (total thickness, ie width); <code>ends= x-x</code> or <code>-x</code> or <code>x-</code> where <i>x</i> is ! (half-width line) or (full-width line).
dline(linespec,t,t,width,parameters)	darrow	See also <code>Dline</code> . Double line, truncated by half width at either end, closed at either or both ends. <i>parameters</i> = <code>x-x</code> or <code>-x</code> or <code>x-</code> where <i>x</i> is ! (half-width line) or (full-width line).
dlinewidth	darrow	width of double lines
dljust(at location)	darrow	ljust (displaced <code>dlinewidth</code> /2)
dn_	gen	down with respect to current direction
dna_	cct	internal character sequence that specifies which subcomponents are drawn
dot(at location,radius,fill)	gen	filled circle (third arg= gray value: 0=black, 1=white)
dot3D(x1,y1,z1,x2,y2,z2)	3D	dot product of two triples
dotrad_	gen	dot radius
down_	gen	sets current direction to down (Section 5)
dright	darrow	double arrow right turn
drjust(at location)	darrow	rjust (displaced <code>dlinewidth</code> /2)
dswitch(linespec,L R,W[ud]B[K]chars)		

	cct	SPST switch left or right, W=baseline, B=contact blade, dB=contact blade to the right of drawing direction, Bm = mirror contact blade, Bo = contact blade more widely open, Cb = circuit-breaker function, Co = contactor function, C = external operating mechanism, D = circle at contact and hinge, (dD = hinge only, uD = contact only) E = emergency button, EL = early close (or late open), LE = late close (or early open), F = fused, H = time delay closing, uH = time delay opening, HH = time delay opening and closing, K=vertical closing contact line, L = limit, M = maintained (latched), MM = momentary contact on make, MR = momentary contact on release, MMR = momentary contact on make and release, O = hand operation button, P = pushbutton, Pr[T M] = proximity (touch-sensitive or magnetically controlled), Th = thermal control linkage, Tr = tripping, Y = pull switch, Z = turn switch (Section 4.2)
	darrow	double arrow tee junction with tail to left, right, or (default) back along current direction
	gen	degrees to radians conversion constant
	darrow	turn dline arg1 degrees left (ccw)
E	gen	the constant e
	gen	.e relative to current direction
	cct	left or right, N or P enhancement MOSFET, normal or simplified, without or with envelope (Section 6.1)
	cct	earphone, $In1$ to $In3$ defined (Section 6)
	cct	two-terminal box element with adjustable dimensions and fill value 0 (black) to 1 (white). $lgth$ (length) and $wdth$ (width) are relative to the direction of $linespec$. Alternatively, argument 1 is the $linespec$ and argument 2 is a semicolon-separated sequence of key=value terms. The possible keys are $lgth$, $wdth$, $text$, box , e.g., $lgth=0.2$; $text="XX"$; $box=shaded "green"$ (Section 4.2)
	gen	chop for ellipses: evaluates to chop r where r is the distance from the centre of ellipse Name1 to the intersection of the ellipse with a line to location Name2; e.g., line from A to E elchop(E,A)
	cct	internal line initialization
	cct	default element length
	cct	radiation arrows, N=nonionizing, I=ionizing, E=simple; D=dot (Section 4.2)
	gen	end gray shading, see beginshade
	gen	Calculates location named $Result$ equidistant from the first three positions, i.e. the centre of the circle passing through the three positions. If arg5 is nonblank, it is equated to the radius.

expe	gen	exponential, base e
F f_box(<i>boxspecs</i> , <i>text</i> , <i>expr1</i> , ...)	gen	like s_box but the text is overlaid on a box of identical size. If there is only one argument then the default box is invisible and filled white (Section 13)
Fector(<i>x1,y1,z1,x2,y2,z2</i>)	3D	vector projected on current view plane with top face of 3-dimensional arrowhead normal to x_2,y_2,z_2
Fe_fet(<i>linespec</i> , <i>R</i> , <i>chars</i>)	cct	FET with superimposed ferroelectric symbol. Args 1 to 3 are as for the mosfet macro (Section 6.1)
FF_ht	cct	flipflop height parameter in L_units
FF_wid	cct	flipflop width parameter in L_units
fill_(<i>number</i>)	gen	fill macro, 0=black, 1=white (Section 6.1)
fitcurve(<i>V,n</i> , [e.g. dotted], <i>m</i> (default 0))	gen	Draw a spline through positions $V[m]$, <i>ldots</i> $V[n]$: Works only with dpic.
FlipFlop(<i>D T RS JK</i> , <i>label</i> , <i>boxspec</i> , <i>pinlength</i>)	log	flip-flops, <i>boxspec</i> =e.g. ht x wid y (Section 9)
FlipFlop6(<i>label</i> , <i>spec</i> , <i>boxspec</i>)	log	<i>This macro (6-input flip-flops) has been superseded by FlipFlopX and may be deleted in future.</i> <i>spec</i> =[<i>[n]NQ</i>] [<i>[n]Q</i>] [<i>[n]CK</i>] [<i>[n]PR</i>] [<i>1b</i>] [<i>[n]CLR</i>] [<i>[n]S</i>] [<i>[n]. D T R</i>] to include and negate pins, <i>1b</i> to print labels
FlipFlopJK(<i>label</i> , <i>spec</i> , <i>boxspec</i>)	log	<i>This macro (JK flip-flop) has been superseded by FlipFlopX and may be deleted in future.</i> Similar to FlipFlop6.
FlipFlopX(<i>boxspec</i> , <i>label</i> , <i>leftpins</i> , <i>toppins</i> , <i>rightpins</i> , <i>bottompins</i> , <i>pinlength</i>)	log	General flipflop. Arg 1 modifies the box (labelled Chip) default specification. Each of args 3 to 6 is null or a string of <i>pinspecs</i> separated by semicolons (;). A <i>Pinspec</i> is either empty or of the form [<i>pinopts</i>]: [<i>label</i> [: <i>Picname</i>]]]. The first colon draws the pin. Pins are placed top to bottom or left to right along the box edges with null <i>pinspecs</i> counted for placement. Pins are named by side and number by default; eg <i>W1</i> , <i>W2</i> , ..., <i>N1</i> , <i>N2</i> , ..., <i>E1</i> , ..., <i>S1</i> , ...; however, if <i>:Picname</i> is present in a <i>pinspec</i> then <i>Picname</i> replaces the default name. A <i>pinspec</i> label is text placed at the pin base. Semicolons are not allowed in labels; use, e.g., <code>\char59{}</code> instead. To put a bar over a label, use <code>lg_bartxt(<i>label</i>)</code> . The <i>pinopts</i> are [<i>N L M</i>] [<i>E</i>]; <i>N</i> =pin with not circle; <i>L</i> =active low out; <i>M</i> =active low in; <i>E</i> =edge trigger (Section 9). Optional arg 7 is the length of pins
for_(<i>start</i> , <i>end</i> , <i>increment</i> , 'actions')	gen	integer for loop with index variable <i>m4x</i> (Section 8)
foreach_('variable', <i>actions</i> , <i>value1</i> , <i>value2</i> , ...)	gen	Clone of Loopover_ by a different name: Repeat <i>actions</i> with <i>variable</i> set successively to <i>value1</i> , <i>value2</i> , ..., setting macro <i>m4Lx</i> to 1, 2, ..., terminating if <i>variable</i> is null
FTcap(<i>chars</i>)	cct	Feed-through capacitor; example of a composite element derived from a two-terminal element. Defined points: <i>.Start</i> , <i>.End</i> , <i>.C</i> <i>.T1</i> <i>.T2</i> <i>T</i> Arg 1: (default) <i>A</i> = type A, <i>B</i> = type B, <i>C</i> = type C (Section 6)

	<code>fuse(<i>linespec, type, wid, ht</i>)</code>	cct	fuse symbol, type= A B C D S HB HC SB or dA=D (Section 4.2)
G	<code>g_</code>	gen	green color value
	<code>G_hht</code>	log	gate half-height in <code>L_units</code>
	<code>g_fet(<i>linespec,R,P,shade spec</i>)</code>	cct	left or right, N or P graphene FET, without or with shading (Section 6.1)
	<code>gap(<i>linespec,fill,A</i>)</code>	cct	gap with (filled) dots, A=chopped arrow between dots (Section 4.2)
	<code>gen_init</code>	gen	initialize environment for general diagrams (customizable, reads <code>libgen.m4</code>)
	<code>glabel_</code>	cct	internal general labeller
	<code>gpolyline_(<i>fraction,location, ...</i>)</code>	gen	internal to <code>gshade</code>
	<code>graystring(<i>gray value</i>)</code>	gen	evaluates to a string compatible with the postprocessor in use to go with <code>colored</code> , <code>shaded</code> , or <code>outlined</code> attributes. (PSTricks, metapost, pgf-tikz, pdf, postscript, svg). The argument is a fraction in the range [0, 1]; see <code>rgbstring</code>
	<code>grid_(<i>x,y</i>)</code>	log	absolute grid location
	<code>ground(at <i>location, T stem length, N F S L P A E, U D L R degrees</i>)</code>	cct	ground, without stem for 2nd arg = T; N=normal, F=frame, S=signal, L=low-noise, P=protective, PA=protective alternate, E=European; up, down, left, right, or angle from horizontal (default -90) (Section 6)
	<code>gshade(<i>gray value,A,B,...,Z,A,B</i>)</code>	gen	(Note last two arguments). Shade a polygon with named vertices, attempting to avoid sharp corners
	<code>gyrator(<i>box specs,space ratio,pin lgth,[N][V]</i>)</code>	cct	Gyrator two-port wrapper for <code>nport</code> , N omits pin dots; V gives a vertical orientation (Section 6)
H	<code>H_ht</code>	log	hysteresis symbol dimension in <code>L_units</code>
	<code>Header(1 2,<i>rows,wid,ht,box attributes</i>)</code>	log	Header block with 1 or 2 columns and square Pin 1: arg1 = number of columns; arg2 = pins per column; arg3,4 = custom wid, ht; arg5 = e.g., <code>fill_(0.9)</code> (Section 6)
	<code>HeaderPin(<i>location, type, Picname,n e s w,length</i>)</code>	log	General pin for <code>Header</code> macro; arg 4 specifies pin direction with respect to the current drawing direction)
	<code>hatchbox(<i>boxspec,hashsep,hatchspec</i>)</code>	gen	Manhattan box with 45 degree hatching, e.g., <code>hatchbox(outlined "blue",dashed outlined "green" thick 0.4)</code>
	<code>heater(<i>linespec, ndivisions, wid, ht</i>)</code>	cct	heater element (Section 4.2)
	<code>hex_digit(<i>n</i>)</code>	gen	hexadecimal digit for $0 \leq n < 16$
	<code>hexadecimal_(<i>n, [m]</i>)</code>	gen	hexadecimal representation of <i>n</i> , left padded to <i>m</i> digits if the second argument is nonblank
	<code>hlth</code>	gen	current line half thickness in drawing units
	<code>hoprad_</code>	cct	hop radius in crossover macro
	<code>ht_</code>	gen	height relative to current direction

I	<code>ifdpic</code> (<i>if true, if false</i>)	gen	test if dpic has been specified as pic processor
	<code>ifgpic</code> (<i>if true, if false</i>)	gen	test if gpic has been specified as pic processor
	<code>ifinstr</code> (<i>string, string, if true, if false</i>)	gen	test if the second argument is a substring of the first; also <code>ifinstr</code> (<i>string, string, if true, string, string, if true, ... if false</i>)
	<code>ifmfpic</code> (<i>if true, if false</i>)	gen	test if mfpic has been specified as pic post-processor
	<code>ifmpost</code> (<i>if true, if false</i>)	gen	test if MetaPost has been specified as pic post-processor
	<code>ifpgf</code> (<i>if true, if false</i>)	gen	test if Tikz PGF has been specified as pic post-processor
	<code>ifpostscript</code> (<i>if true, if false</i>)	gen	test if Postscript (<code>dpic -r</code>) has been specified as pic output format
	<code>ifpsfrag</code> (<i>if true, if false</i>)	gen	Test if either <code>psfrag</code> or <code>psfrag_</code> has been defined. For postscript with <code>psfrag</code> strings, one or the other should be defined prior to or at the beginning of the diagram
	<code>ifpstricks</code> (<i>if true, if false</i>)	gen	test if PSTricks has been specified as post-processor
	<code>ifroff</code> (<i>if true, if false</i>)	gen	test if troff or groff has been specified as post-processor
	<code>ifxfig</code> (<i>if true, if false</i>)	gen	test if Fig 3.2 (<code>dpic -x</code>) has been specified as pic output format
	<code>igbt</code> (<i>linespec, L R, [L] [[d]D]</i>)	cct	left or right IGBT, L=alternate gate type, D=parallel diode, dD=dotted connections
	<code>in_</code>	gen	absolute inches
	<code>inductor</code> (<i>linespec, W L, cycles, M[n] P[n] K[n], loop wid</i>)	cct	inductor, arg2: narrow (default), W=wide, L=looped; arg3: number of arcs or cycles (default 4); arg4: M=magnetic core, P=powder (dashed) core, K=long-dashed core, n= <i>integer</i> (default 2) number of core lines named <i>M4Core1, M4Core2, ...</i> ; arg5: loop width (default L,W: <code>dimen_/5</code> ; other: <code>dimen_/8</code>) (Section 4.2)
	<code>inner_prod</code> (<i>linear obj, linear obj</i>)	gen	inner product of (x,y) dimensions of two linear objects
	<code>Int_</code>	gen	corrected (old) <code>gpic int()</code> function
	<code>integrator</code> (<i>linespec, size</i>)	cct	integrating amplifier (Section 4.2)
	<code>intersect_</code> (<i>line1.start, line1.end, line2.start, line2.end</i>)	gen	intersection of two lines
	<code>Intersect_</code> (<i>Name1, Name2</i>)	gen	intersection of two named lines
	<code>I0defs</code> (<i>linespec, label, [P N]*, L R</i>)	log	Define locations <i>label1, ... labeln</i> along the line; P= label only; N=with <code>NOT_circle</code> ; R=circle to right of current direction
J	<code>j_fet</code> (<i>linespec, L R, P, E</i>)	cct	left or right, N or P JFET, without or with envelope (Section 6.1)
	<code>jack</code> (<i>U D L R degrees, chars</i>)	cct	arg1: drawing direction; string arg2: R=right orientation, one or more L[M] [B] for L and auxiliary contacts with make or break points; S[M] [B] for S and auxiliary contacts (Section 6)
K	<code>KelvinR</code> (<i>cycles, [R], cycle wid</i>)	cct	IEEE resistor in a [] block with Kelvin taps <i>T1</i> and <i>T2</i> (Section 6)
L	<code>L_unit</code>	log	logic-element grid size
	<code>lamp</code> (<i>linespec, [R]</i>)	cct	Two-terminal incandescent lamp (Section 4.2)

<code>larrow(label, -> <- , dist)</code>	cct	arrow <i>dist</i> to left of last-drawn 2-terminal element (Section 4.3)
<code>lbox(wid, ht, attributes)</code>	gen	box oriented in current direction, arg 3= e.g. dashed shaded "red"
<code>LCintersect(line name, Centre, rad, [R])</code>	gen	First (second if arg4 is R) intersection of a line with a circle
<code>LCtangent(Pos1, Centre, rad, [R])</code>	gen	Left (right if arg4=R) tangent point of line from Pos1 to circle at Centre with radius arg3
<code>left_</code>	gen	left with respect to current direction (Section 5)
<code>length3D(x,y,z)</code>	3D	Euclidean length of triple x,y,z
<code>LEintersect(line name, Centre, ellipse wid, ellipse ht, [R])</code>	gen	First (second if arg5 is R) intersection of a line with an ellipse
<code>LEtangent(Pos1, Centre, ellips wid, ellipse ht [R])</code>	gen	Left (right if arg5=R) tangent point of line from Pos1 to ellipse at Centre with given width and height
<code>lg_bartxt</code>	log	draws an overline over logic-pin text (except for xfig)
<code>lg_pin(location, label, Picname, n e s w[L M I O] [N] [E] , pinno, optlen)</code>	log	comprehensive logic pin; <i>label</i> = text (indicating logical pin function, usually), <i>Picname</i> = pic label for referring to the pin (line), <i>n e s w</i> =orientation (north, south, east, west), <i>L</i> =active low out, <i>M</i> =active low in, <i>I</i> =inward arrow, <i>O</i> =outward arrow, <i>N</i> =negated, <i>E</i> =edge trigger
<code>lg_pintxt</code>	log	reduced-size text for logic pins
<code>lg_plen</code>	log	logic pin length in in <i>L_units</i>
<code>LH_symbol([U D L R degrees] [I])</code>	log	logic-gate hysteresis symbol; <i>I</i> =inverted
<code>lin_ang(line-reference)</code>	gen	the angle from <i>.start</i> to <i>.end</i> of a line or move
<code>lin_leng(line-reference)</code>	gen	length of a line, equivalent to <i>line-reference.len</i> with <i>dpic</i>
<code>linethick_(number)</code>	gen	set line thickness in points
<code>ljust_</code>	gen	<i>ljust</i> with respect to current direction
<code>llabel(label, label, label, arg4, arg5)</code>	cct	Triple label on the left of an element with respect to the current direction (Section 4.4). Labels are placed at the beginning, centre, or end of the last <code>[]</code> block (or a named <code>[]</code> block). The labels are treated as math, but copied literally if in double quotes or defined by <code>sprintf</code> . <i>Arg4</i> can be above , below , left , or right to supplement the default position. <i>Arg5</i> is the optional name of a <code>[]</code> block to be labelled and is last [] by default
<code>loc_(x, y)</code>	gen	location adjusted for current direction
<code>log_init</code>	log	initialize environment for logic diagrams (customizable, reads <code>liblog.m4</code>)
<code>log10E_</code>	gen	constant $\log_{10}(e)$
<code>loge</code>	gen	logarithm, base <i>e</i>
<code>Loopover_('variable', actions, value1, value2, ...)</code>	gen	Repeat <i>actions</i> with <i>variable</i> set successively to <i>value1</i> , <i>value2</i> , ..., setting macro <code>m4Lx</code> to 1, 2, ..., terminating if <i>variable</i> is <code>nul</code>

lp_xy	log	coordinates used by lg_pin
lpop(<i>xcoord, ycoord, radius, fill, zero ht</i>)	gen	for lollipop graphs: filled circle with stem to (<i>xcoord,zeroht</i>)
lswitch(<i>linespec, L R, chars</i>)	cct	knife switch R=right orientation (default L=left); <i>chars</i> =[O C][D][K][A] O=opening arrow; C=closing arrow; D=dots; K=closed switch; A=blade arrowhead (Section 4.2)
lt_	gen	left with respect to current direction
LT_symbol(U D L R degrees)	log	logic-gate triangle symbol
lthick	gen	current line thickness in drawing units
M m4_arrow(<i>linespec, ht, wid</i>)	gen	arrow with adjustable head, filled when possible
m4dupstr(<i>string, n, 'name'</i>)	gen	Defines <i>name</i> as <i>n</i> concatenated copies of <i>string</i> .
m4lstring(<i>arg1, arg2</i>)	gen	expand <i>arg1</i> if it begins with <code>sprintf</code> or <code>"</code> , otherwise <i>arg2</i>
m4xpcand(<i>arg</i>)	gen	Evaluate the argument as a macro
m4xtract('string1', <i>string2</i>)	gen	delete <i>string2</i> from <i>string1</i> , return 1 if present
manhattan	gen	sets direction cosines for left, right, up, down
Max(<i>arg, arg, ...</i>)	gen	Max of an arbitrary number of inputs
memristor(<i>linespec, wid, ht</i>)	cct	memristor element (Section 4.2)
microphone(A U D L R degrees, <i>size</i>)	cct	microphone; if <i>arg1</i> = A: upright mic, otherwise <i>arg1</i> sets direction of standard microphone with <i>In1</i> to <i>In3</i> defined (Section 6)
Min(<i>arg, arg, ...</i>)	gen	Min of an arbitrary number of inputs
Mitre_(<i>Line1, Line2, length, line attributes</i>)	gen	e.g., Mitre_(L,M) draws angle at intersection of lines L and M with legs of length <i>arg3</i> (default <code>linethick bp_/2</code>); sets <code>Here</code> to intersection (Section 7)
mitre_(<i>Position1, Position2, Position3, length, line attributes</i>)	gen	e.g., mitre_(A,B,C) draws angle ABC with legs of length <i>arg4</i> (default <code>linethick bp_/2</code>); sets <code>Here</code> to <i>Position2</i> (Section 7)
mm__	gen	absolute millimetres
mosfet(<i>linespec, L R, chars, E</i>)	cct	MOSFET left or right, included components defined by characters, envelope. <i>arg 3</i> chars: [u] [d]B: center bulk connection pin; D: D pin and lead; E: dashed substrate; F: solid-line substrate; [u] [d]G: G pin to substrate at source; [u] [d]H: G pin to substrate at center; L: G pin to channel (obsolete); [u] [d]M: G pin to channel; u: at drain end; d: at source end [u] [d]Mn: multiple gates G0 to Gn Py: parallel diode; Pz: parallel zener diode; Q: connect B pin to S pin; R: thick channel; [u] [d]S: S pin and lead u: arrow up; d: arrow down; [d]T: G pin to center of channel d: not circle; X: XMOSFET terminal; Z: simplified complementary MOS (Section 6.1)
Mux_ht	cct	Mux height parameter in L_units
Mux_wid	cct	Mux width parameter in L_units
Mux(<i>n, label, [L] [B H X] [N[n] S[n]] [[N]OE], wid, ht</i>)		

	log	binary multiplexer, n inputs, L reverses input pin numbers, B display binary pin numbers, H display hexadecimal pin numbers, X do not print pin numbers, N[n] puts Sel or Sel0 .. Sel n at the top (i.e., to the left of the drawing direction), S[n] puts the Sel inputs at the bottom (default) OE (N=negated) OE pin (Section 9)
Mx_pins	log	max number of gate inputs without wings
N n_	gen	.n with respect to current direction
N_diam	log	diameter of 'not' circles in L_units
N_rad	log	radius of 'not' circles in L_units
NAND_gate(n,N)	log	'nand' gate, 2 or n inputs; N=negated input. Otherwise, arg1 can be a sequence of letters P N to define normal or negated inputs. (Section 9)
ne_	gen	.ne with respect to current direction
NeedDpicTools	gen	executes copy "HOMELIB_/dpictools.pic" if the file has not been read
neg_	gen	unary negation
NOR_gate(n,N)	log	'nor' gate, 2 or n inputs; N=negated input. Otherwise, arg1 can be a sequence of letters P N to define normal or negated inputs. (Section 9)
norator(<i>linespec, width, ht</i>)	cct	norator two-terminal element (Section 4.2)
NOT_circle	log	'not' circle
NOT_gate(<i>linespec, [B] [N n], wid, height</i>)	log	'not' gate. When <i>linespec</i> is blank then the element is composite and In1, Out, C, NE, and SE are defined; otherwise the element is drawn as a two-terminal element. arg2: B=box gate, N=not circle at input and output, n=not circle at input only (Section 9)
NOT_rad	log	'not' radius in absolute units
NPDT(<i>npoles, [R]</i>)	cct	Double-throw switch; <i>npoles</i> : number of poles; R= right orientation with respect to drawing direction (Section 6)
nport(<i>box spec; other commands, nw,nn,ne,ns,space ratio,pin lgth,style, other commands</i>)	cct	Default is a standard-box twoport. Args 2 to 5 are the number of ports to be drawn on w, n, e, s sides. The port pins are named by side, number, and by a or b pin, e.g., W1a, W1b, W2a, ... Arg 6 specifies the ratio of port width to interport space (default 2), and arg 7 is the pin length. Set arg 8 to N to omit the dots on the port pins. Arguments 1 and 9 allow customizations (Section 6)
nterm(<i>box spec; other commands, nw,nn,ne,ns,pin lgth,style, other commands</i>)	cct	n-terminal box macro (default three pins). Args 2 to 5 are the number of pins to be drawn on W, N, E, S sides. The pins are named by side and number, e.g. W1, W2, N1, ... Arg 6 is the pin length. Set arg 7 to N to omit the dots on the pins. Arguments 1 and 8 allow customizations, e.g. nterm(,,,,N,"a\$" at Box.w ljust,"b\$" at Box.e rjust, "c\$" at Box.s above)
nullator(<i>linespec, width, ht</i>)	cct	nullator two-terminal element (Section 4.2)
nw_	gen	.nw with respect to current direction

	NXOR_gate(<i>n,N</i>)	log	'nxor' gate, 2 or <i>n</i> inputs; N=negated input. Otherwise, arg1 can be a sequence of letters P N to define normal or negated inputs. (Section 9)
O	opamp(<i>linespec, label, label, size, chars,</i>	other commands	
	cct		operational amplifier with -, + or other internal labels, specified size. <i>chars</i> : P= add power connections, R= swap In1, In2 labels, T= truncated point. The internally defined positions are <i>W, N, E, S, Out, NE, SE, In, In2</i> , and the (obsolete) positions <i>E1 = NE, E2 = SE</i> . The first and last arguments allow added customizations (Section 6)
	open_arrow(<i>linespec, ht, wid</i>)	gen	arrow with adjustable open head
	OR_gate(<i>n,N</i>)	log	'or' gate, 2 or <i>n</i> inputs; N=negated input. Otherwise, arg1 can be a sequence of letters P N to define normal or negated inputs. (Section 9)
	OR_gen(<i>n, chars, [wid, [ht]]</i>)	log	general OR gate: <i>n</i> =number of inputs ($0 \leq n \leq 16$); <i>chars</i> : B=base and straight sides; A=Arcs; [N]NE,[N]SE,[N]I,[N]N,[N]S=inputs or circles; [N]P=XOR arc; [N]O=output; C=center. Otherwise, arg1 can be a sequence of letters P N to define normal or negated inputs.
	OR_rad	log	radius of OR input face in L_units
P	parallel_('elementspec', 'elementspec'...)		
	cct		Parallel combination of two-terminal elements in a [] block. Each argument is a <i>quoted</i> elementspec of the form [Sep=val;] [Label:] element; [attributes] where an attribute is of the form [llabel(...);] [rlabel(...);] [b_current(...);]. An argument may also be series_(...) or parallel_(...) without attributes or quotes. Sep=val; in the first branch sets the default separation of all branches to val; in a later element Sep=val; applies only to that branch. An element may have normal arguments but should not change the drawing direction. (Section 5.1)
	proximity(<i>linespec</i>)	cct	proximity detector (= consource(,P))
	pc__	gen	absolute points
	pvcell(<i>linespec, width, height</i>)	cct	PV cell
	px__	gen	absolute SVG screen pixels
	pconnex(<i>R L U D degrees, chars</i>)		
	cct		power connectors, arg 1: drawing direction; <i>chars</i> : R=right orientation, M F= male, female, A AC=115V, 3 prong, B=box, C=circle, P= PC connector, D= 2-pin connector, G GC= GB 3-pin, J= 110V 2-pin (Section 6)
	pi_	gen	π
	plug(<i>U D L R degrees, [2 3] [R]</i>)		
	cct		arg1: drawing direction; string arg2: R right orientation, 2 3 number of conductors (Section 6)
	pmod(<i>integer, integer</i>)	gen	+ve mod(<i>M, N</i>) e.g., pmod(-3, 5) = 2
	point_(<i>angle</i>)	gen	(radians) set direction cosines
	perpto(<i>Pos1, Line, Point</i>)	gen	<i>Point</i> is the label for the point on <i>Line</i> of the perpendicular from <i>Point</i> to <i>Line</i> .
	PerpTo(<i>Pos1, Pos2, Pos3</i>)	gen	The point between Pos2 and Pos3 of intersection of the perpendicular to Pos1, i.e., the perpendicular projection of Pos1 onto the line from Pos2 to Pos3.

	<code>Point_(integer)</code>	gen	sets direction cosines in degrees (Section 5)
	<code>polar_(x,y)</code>	gen	rectangular-to polar conversion
	<code>langle(Start, End)</code>	gen	Angle in radians from horizontal of the line from <i>Start</i> to <i>End</i> .
	<code>potentiometer(linespec,cycles,fractional pos,length,...)</code>	cct	resistor with taps T1, T2, ... with specified fractional positions and lengths (possibly neg) (Section 6)
	<code>print3D(x,y,z)</code>	3D	write out triple for debugging
	<code>prod_(a,b)</code>	gen	binary multiplication
	<code>project(x,(y,(z)</code>	3D	3D to 2D projection onto the plane perpendicular to the view vector with angles defined by <code>setview(azim, elev)</code>
	<code>psset_(PSTricks settings)</code>	gen	set PSTricks parameters
	<code>pt__</code>	gen	TeX point-size factor, in scaled inches, (<code>*scale/72.27</code>)
	<code>PtoL(position, U D L R degrees, length)</code>	gen	Evaluates to <code>from position to position + Rect_(length, angle)</code> from the polar-coordinate data in the arguments
	<code>ptrans(linespec, [R L])</code>	cct	pass transistor; L= left orientation (Section 6.1)
R	<code>r_</code>	gen	red color value
	<code>rarrow(label,-> <- ,dist)</code>	cct	arrow <i>dist</i> to right of last-drawn 2-terminal element (Section 4.3)
	<code>Rect_(radius,angle)</code>	gen	(deg) polar-to-rectangular conversion
	<code>rect_(radius,angle)</code>	gen	(radians) polar-rectangular conversion
	<code>reed(linespec, width, height, box attribues, [R][C])</code>	cct	Enclosed reed two-terminal contact; R=right orientation; C=closed contact; e.g., <code>reed(„dimen_/5,shaded "lightgreen"</code> (Section 6)
	<code>relay(number of poles, chars)</code>	cct	relay: n poles (default 1), <i>chars</i> : 0=normally open, C=normally closed, P=three position, default double throw, L=drawn left (default), R=drawn right, Th=thermal. Argument 3=[L R] is deprecated but works for backward compatibility (Section 6)
	<code>relaycoil(chars, wid, ht, R L U D degrees)</code>	cct	<i>chars</i> : X=or default: external lines from A2 and B2; AX=external lines at positions A1,A3; BX=external lines at positions B1,B3; NX=no lines at positions A1,A2,A3,B1,B2,B3; SO=slow operating; SOR=slow operating and release; SR=slow release; HS=high speed; NAC=unaffected by AC current; AC AC=current; ML=mechanically latched; PO=polarized; RM=remanent; RH=remanent; TH=thermal; EL=electronic (Section 6)
	<code>resetdir_</code>	gen	resets direction set by <code>setdir_</code>
	<code>resetrgb</code>	gen	cancel <code>r_</code> , <code>g_</code> , <code>b_</code> color definitions
	<code>resistor(linespec,n E,chars, cycle wid)</code>	cct	resistor, n cycles (default 3), <i>chars</i> : AC=general complex element, E=ebox, ES=ebox with slash, Q=offset, H=squared, N=IEEE, B=not burnable, V=varistor variant, R=right-oriented, <i>cycle width</i> (default <code>dimen_/6</code>) (Section 4.2)
	<code>resized(factor, 'macro name', args)</code>	cct	scale the element body size by <i>factor</i>

<code>restorem4dir(['stack name'])</code>	gen	Restore m4 direction parameters from the named stack; default <code>'savm4dir_'</code>
<code>reversed('macro name', args)</code>	cct	reverse polarity of 2-terminal element
<code>rgbdraw(color triple, drawing commands)</code>	gen	color drawing for PSTricks, pgf, MetaPost, SVG postprocessors; (color entries are 0 to 1 except for SVG entries which are 0 to 255), see <code>setrgb</code> (Section 6.1). Exceptionally, the color of SVG arrows other than the default black has to be defined using the <code>outlined string</code> and <code>shaded string</code> constructs.
<code>rgbfill(color triple, closed path)</code>	gen	fill with arbitrary color (color entries are 0 to 1 except SVG entries which are 0 to 255); see <code>setrgb</code> (Section 6.1)
<code>rgbstring(color triple or color name)</code>	gen	evaluates to a string compatible with the postprocessor in use to go with <code>colored</code> , <code>shaded</code> , or <code>outlined</code> attributes. (PSTricks, metapost, pgf-tikz, pdf, postscript, svg). The arguments are fractions in the range [0,1]; For example, <code>box outlined rgbstring(0.1,0.2,0.7) shaded rgbstring(0.75,0.5,0.25)</code> . For those postprocessors that allow it, there can be one argument which is the name of a defined color
<code>right_</code>	gen	set current direction right (Section 5)
<code>RightAngle(Pos1, Pos2, Pos3, line len, attributes)</code>	gen	Draw a right-angle symbol at <code>Pos2</code> , of size given by <code>arg4</code> . <code>Arg5</code> = line attributes, e.g., <code>outlined "gray"</code>
<code>rjust_</code>	gen	right justify with respect to current direction
<code>rlabel(label, label, label, arg4, arg5)</code>	cct	Triple label on the right of an element with respect to the current direction (Section 4.4). Labels are placed at the beginning, centre, or end of the last <code>[]</code> block (or a named <code>[]</code> block). The labels are treated as math, but copied literally if in double quotes or defined by <code>sprintf</code> . <code>Arg4</code> can be <code>above</code> , <code>below</code> , <code>left</code> , or <code>right</code> to supplement the default position. <code>Arg5</code> is the optional name of a <code>[]</code> block to be labelled and is <code>last []</code> by default
<code>rot3Dx(radians,x,y,z)</code>	3D	rotates x,y,z about x axis
<code>rot3Dy(radians,x,y,z)</code>	3D	rotates x,y,z about y axis
<code>rot3Dz(radians,x,y,z)</code>	3D	rotates x,y,z about z axis
<code>Rot_(position, degrees)</code>	gen	rotate position by degrees
<code>rot_(x, y, angle)</code>	gen	rotate x,y by theta radians
<code>rotbox(wid,ht,type, [r t=val])</code>	gen	box oriented in current direction in <code>[]</code> block; <code>type</code> = e.g. <code>dotted shaded "green"</code> . Defined internal locations: N, E, S, W (and NE, SE, NW, SW if <code>arg4</code> is blank). If <code>arg4</code> is <code>r=val</code> then corners have radius <code>val</code> . If <code>arg4</code> is <code>t=val</code> then a spline with tension <code>val</code> is used to draw a "superellipse," and the bounding box is then only approximate.
<code>rotellipse(wid,ht,type)</code>	gen	ellipse oriented in current direction in <code>[]</code> block; e.g. <code>Point_(45); rotellipse(,dotted fill_(0.9))</code> . Defined internal locations: N, S, E, W.
<code>round(at location,line thickness,attributes)</code>		

	gen	filled circle for rounded corners; attributes=colored "gray" for example; leaves Here unchanged if arg1 is blank (Section 7)
rpoint_(linespec)	gen	set direction cosines
rpos_(position)	gen	Here + position
rrot_(x, y, angle)	gen	Here + vrot_(x, y, cos(angle), sin(angle))
rs_box(text, expr1, ...)	gen	like s_box but the text is rotated by text_ang (default 90) degrees (Section 13), (Section 14)
rsvec_(position)	gen	Here + position
rt_	gen	right with respect to current direction
rtod__	gen	constant, degrees/radian
rtod_	gen	constant, degrees/radian
rvec_(x,y)	gen	location relative to current direction
S s_	gen	.s with respect to current direction
s_box(text, expr1, ...)	gen	generate dimensioned text string using \boxdims from boxdims.sty. Two or more args are passed to sprintf() (default 90) degrees (Section 13)
s_dp(name, default)	gen	depth of the most recent (or named) s_box (Section 13)
s_ht(name, default)	gen	height of the most recent (or named) s_box (Section 13)
s_init(name)	gen	initialize s_box string label to name which should be unique (Section 13)
s_name	gen	the value of the last s_init argument (Section 13)
s_wd(name, default)	gen	width of the most recent (or named) s_box (Section 13)
sarrow(linespec, keys)	gen	Single-segment, single-headed special arrows. The keys are type=0[pen] (default) D[iamond] C[rowfoot] P[lain]; width=expression; (default arrowwid) lgth=expression; (default arrowht) shaft=shaft attributes (e.g., dashed); head=head attributes (e.g., shaded); (Section 12.1)
savem4dir(['stack name'])	gen	Stack m4 direction parameters in the named stack (default 'savm4dir_')
sbs(linespec, chars, label)	cct	Wrapper to place an SBS thyristor as a two-terminal element with [] block label given by the third argument (Section 6.1)
sc_draw(dna string, chars, iftrue, iffalse)	cct	test if chars are in string, deleting chars from string
scr(linespec, chars, label)	cct	Wrapper to place an SCR thyristor as a two-terminal element with [] block label given by the third argument (Section 6.1)
scs(linespec, chars, label)	cct	Wrapper to place an SCS thyristor as a two-terminal element with [] block label given by the third argument (Section 6.1)
se_	gen	.se with respect to current direction
series_(elementspec, elementspec, ...)	cct	Series combination in a [] block of elements with shortened default length. An elementspec is of the form [Label:] element; [attributes], where an attribute is of the form [llabel(...);] [rlabel(...);] [b_current(...);]. Internal points Start, End, and C are defined (Section 5.1)

`setdir_(R|L|U|D|degrees, default U|D|R|L|degrees)`
gen store drawing direction and set it to up, down, left, right, or angle in degrees (reset by `resetdir_`). The directions may be spelled out, i.e., Right, Left, ... (Section 5.1)

`setrgb(red value, green value, blue value, [name])`
gen define colour for lines and text, optionally named (default `lcspec`); svg values are integers from 0 to 255 (Section 6.1)

`setkey_(string, key, default, [N])`
gen Key-value definition. The string contains semicolon-separated terms of the form `key=value`. Then macro `m4key` is defined using `pushdef` to be (`value`) but if `arg4` is nonbland, the parentheses are omitted.

`setview(azimuth degrees, elevation degrees)`
3D set projection viewpoint

`sfg_init(default line len, node rad, arrowhd len, arrowhd wid), (reads libcct.m4)`
cct initialization of signal flow graph macros

`sfgabove`
cct like above but with extra space

`sfgarc(linespec, text, text justification, cw|ccw, height scale factor)`
cct directed arc drawn between nodes, with text label and a height-adjustment parameter

`sfgbelow`
cct like below but with extra space

`sfgline(linespec, text, text justification)`
cct directed straight line chopped by node radius, with text label

`sfgnode(at location, text, above|below, circle options)`
cct small circle default white interior, with text label. The default label position is inside if the diameter is bigger than `textht` and `textwid`; otherwise it is `sfgabove`. Options such as fill or line thickness can be given.

`sfgself(at location, U|D|L|R|degrees, text, text justification, cw|ccw, scale factor)`
cct self-loop drawn at angle `angle` from a node, with text label and a size-adjustment parameter

`shade(gray value, closed line specs)`
gen Fill arbitrary closed curve

`shadebox(box attributes, shade width)`
gen Box with edge shading. Arg2 is in points. See also `shaded`

`ShadedPolygon(vertexseq, line attributes, degrees, colorseq)`
gen Draws the polygon specified in `arg1` and shades the interior according to `arg4` by drawing lines perpendicular to the angle in `arg3`. The `vertexseq` is a colon (`:`) separated sequence of vertex positions (or names) of the polygon in `cw` or `ccw` order. A `colorseq` is of the form `0, r0,g0,b0, frac1,r1,g1,b1, frac2,r2,g2,b2, ... 1, rn, gn, bn` with $0 < frac1 < frac2 < \dots < 1$

`shadowed(box|circle|ellipse|line, position spec, keys)`
gen Object with specified shadow. `posspec` is e.g., `with .w at ...` or `at position`. The `keys` are `attrib=object attributes`; `shadowthick=expr`; (default `linethick*`)`5/4`), `shadowcolor=string`; (default "gray"), `shadowangle=expr`; (default `-45`) for box only: `rad=expr`;

`shielded('two-terminal element', L|U, line attributes)`
 cct shielding in a [] box for two-terminal element. Arg2= blank (default) to enclose the element body; L for the left side with respect to drawing direction, R for right. Internal points `.Start`, `.End`, and `.C` are defined

`SIdefaults` gen Sets `scale = 25.4` for drawing units in mm, and sets pic parameters `lineht = 12`, `linewid = 12`, `moveht = 12`, `movewid = 12`, `arcrad = 6`, `circrad = 6`, `boxht = 12`, `boxwid = 18`, `ellipseht = 12`, `ellipsewid = 18`, `dashwid = 2`, `arrowht = 3`, `arrowwid = arrowht/2`,

`sign_(number)` gen sign function

`Sin(integer)` gen sine function, *integer* degrees

`sinc(number)` gen the `sinc(x)` function

`sind(arg)` gen sine of an expression in degrees

`sinusoid(amplitude, frequency, phase, tmin, tmax, linetype)`
 gen draws a sinusoid over the interval (t_{\min}, t_{\max}) ; e.g., to draw a dashed sine curve, amplitude *a*, of *n* cycles of length *x* from *A*,
`sinusoid(a, twopi_*n/x, -pi_/2, 0, x, dashed)` with `.Start` at *A*

`source(linespec, V|v|I|i|AC|B|F|G|H|J|Q|L|N|P|S[C[r]]|E[r]|T|X|U|other, diameter, R)`
 cct source, blank or: V = voltage source; v = alternate voltage source; I = current source; i = alternate current source; AC = AC source; B = bulb; F = fluorescent; G = generator; H = step function; L = lamp; N = neon; P = pulse; Q = charge; R = ramp; r = right orientation; S = sinusoid; SC = quarter arc; SE = arc; T = triangle; U = square-wave; X = interior X; other = custom interior label or waveform; arg 4: R = reversed polarity; arg 5 modifies the circle with e.g., color or fill ([Section 4.2](#))

`sourcerad_` cct default source radius

`sp_` gen evaluates to medium space for gpic strings

`speaker(U|D|L|R|degrees, size, H)`
 cct speaker, *In1* to *In7* defined; H=horn ([Section 6](#))

`sprod3D(a, x, y, z)` 3D scalar product of triple x,y,z by a

`sqrta(arg)` gen square root of the absolute value of *arg*; i.e., `sqrt(abs(arg))`

`SQUID(n, diameter, initial angle, ccw|cw)`
 cct Superconducting quantum interface device with *n* junctions labeled *J1*, . . . *Jn* placed around a circle with initial angle -90 deg (by default) with respect to the current drawing direction. The default diameter is `dimen_`

`stackargs_('stackname', args)` gen Stack arg 2, arg 3, ... onto the named stack up to a blank arg

`stackcopy_('name 1', 'name 2')`
 gen Copy stack 1 into stack 2, preserving the order of pushed elements

`stackdo_('stackname', commands)`
 gen Empty the stack to the first blank entry, performing arg 2

`stackexec_('name 1', 'name 2', commands)`

	gen	Copy stack 1 into stack 2, performing arg3 for each nonblank entry
<code>stackprint_('stack name')</code>	gen	Print the contents of the stack to the terminal
<code>stackreverse_('stack name')</code>	gen	Reverse the order of elements in a stack, preserving the name
<code>stacksplit_('stack name', string, separator)</code>	gen	Stack the fields of <i>string</i> left to right separated by nonblank <i>separator</i> (default <code>.</code>). White space preceding the fields is ignored.
<code>sum_(a, b)</code>	gen	binary sum
<code>sum3D(x1, y1, z1, x2, y2, z2)</code>	3D	sum of two triples
<code>sus(linespec, chars, label)</code>	cct	Wrapper to place an SUS thyristor as a two-terminal element with [] block label given by the third argument (Section 6.1)
<code>svec_(x, y)</code>	log	scaled and rotated grid coordinate vector
<code>sw_</code>	gen	<code>.sw</code> with respect to current direction
<code>switch(linespec, L R, [C O D], [B D])</code>	cct	SPST switch (wrapper for <code>bswitch</code> , <code>lswitch</code> , and <code>dswitch</code>), arg2: R=right orientation (default L=left); if arg4=blank (knife switch): arg3 = [O C][D][A] O= opening, C=closing, D=dots, A=blade arrowhead; if arg4=B (button switch): arg3 = O C O=normally open, C=normally closed, if arg4=D: arg3 = same as for <code>dswitch</code> (Section 4.2)
T <code>ta_xy(x, y)</code>	cct	macro-internal coordinates adjusted for L R
<code>tapped('two-terminal element', [arrowhd type=arrowhd; name=Name], fraction, length, fraction, length, ...)</code>	cct	Draw the two-terminal element with taps in a [] block (see <code>addtaps</code>). <i>arrowhd</i> = blank or one of <code>.</code> <code>-</code> <code><-</code> <code>-></code> <code><-></code> . Each fraction determines the position along the element body of the tap. A negative length draws the tap to the right of the current direction; positive length to the left. Tap names are Tap1, Tap2, ... by default or Name1, Name2, ... if specified. Internal block names are <code>.Start</code> , <code>.End</code> , and <code>.C</code> corresponding to the drawn element, and the tap names (Section 6)
<code>tbox(text, wid, ht, < > <>, type)</code>	cct	Pointed terminal box. The <i>text</i> is placed at the rectangular center in math mode unless the text begins with <code>"</code> or <code>sprintf</code> in which case the argument is used literally. Arg 4 determines whether the point is forward, backward, or both with respect to the current drawing direction. (Section 6)
<code>tconn(linespec, > >> < << O[F], wid)</code>	cct	Terminal connector, O=circle; OF=filled circle; <code>></code> or <code>>></code> output connector (default <code>></code>); <code><</code> or <code><<</code> input connector; arg3 is arrowhead width or circle diameter (Section 6)
<code>tgate(linespec, [B] [R L])</code>	cct	transmission gate, B= ebox type; L= oriented left (Section 6.1)
<code>thermocouple(linespec, wid, ht, L R)</code>	cct	Thermocouple drawn to the left (by default) of the <i>linespec</i> line. If the <i>linespec</i> length equals <i>wid</i> (default <code>dimen_/5</code>), then only the two branches appear. R= right orientation. (Section 4.2)

<code>thicklines_(number)</code>	gen	set line thickness in points
<code>thinlines_(number)</code>	gen	set line thickness in points
<code>threeD_init</code>	3D	initialize 3D transformations (reads <code>lib3D.m4</code>)
<code>thyristor(linespec, [SCR SCS SUS SBS IEC] [chars])</code>	cct	Composite thyristor element in [] block: types SCR: silicon controlled rectifier (default), SCS: silicon controlled switch, SUS: silicon unilateral switch, SBS: silicon bilateral switch, IEC: type IEC. <i>Chars</i> to modify or define the element: K: open arrowheads, A: arrowhead, F: half arrowhead, B: bidirectional diode, E: adds envelope, H: perpendicular gate (endpoint G), N: anode gate (endpoint Ga), U: centre line in diodes V: perpendicular gate across arrowhead centre, R=right orientation, E=envelope (Section 6.1)
<code>tikznode(Tikz node name, position)</code>	pgf	insert Tikz code to define a zero-size Tikz node at <i>location</i> (default Here) to assist with inclusion of pic code output in Tikz diagrams. This macro must be invoked in the outermost pic scope. (Section 14.1)
<code>tline(linespec, wid, ht)</code>	cct	transmission line, manhattan direction (Section 4.2)
<code>ToPos(position, U D L R degrees, length)</code>	gen	Evaluates to <code>from position - Rect_(length, angle) to position</code> from the polar-coordinate data in the arguments
<code>tr_xy_init(origin, unit size, sign)</code>	cct	initialize <code>tr_xy</code>
<code>tr_xy(x, y)</code>	cct	relative macro internal coordinates adjusted for L R
<code>transformer(linespec, L R, np, [A P] [W L] [D1 D2 D12 D21], ns)</code>	cct	2-winding transformer or choke with terminals P1, P2, TP, S1, S2, TS: arg2: L = left, R = right, arg3: np primary arcs, arg5: ns secondary arcs, arg4: A = air core, P = powder (dashed) core, W = wide windings, L = looped windings, D1: phase dots at P1 and S1 end; D2 at P2 and S2 end; D12 at P1 and S2 end; D21 at P2 and S1 end (Section 6)
<code>tstrip(R L U D degrees, nterms, chars)</code>	cct	terminal strip, chars: I=invisible terminals, C=circle terminals (default), D=dot terminals, O=omitted separator lines, <code>wid</code> =value; total strip width, <code>ht</code> =value; strip height (Section 6)
<code>ttmotor(linespec, string, diameter, brushwid, brushht)</code>	cct	motor with label (Section 4.2)
<code>twopi_</code>	gen	2π
U <code>ujt(linespec, R, P, E)</code>	cct	unijunction transistor, right, P-channel, envelope (Section 6.1)
<code>unit3D(x, y, z)</code>	3D	unit triple in the direction of triple x,y,z
<code>up__</code>	gen	up with respect to current direction
<code>up_</code>	gen	set current direction up (Section 5)
V <code>variable('element', [A P L u N u NN] [C S], [+ -]angle, length, at position)</code>		

	cct	overlaid arrow or line to indicate variable 2-terminal element: A=arrow, P=preset, L=linear, N= symmetric nonlinear, C=continuous, S=setpwise; u changes the nonlinearity direction. The angle is absolute but preceding it with a sign makes the angle (often -30 or -45) relative to the element drawing direction. If arg5 is blank the symbol is placed over the last [] block (Section 4.2)
Vcoords_(position)	gen	The x,y coordinate pair of the position
Vdiff_(position,position)	gen	Vdiff_(A,B) evaluates to A-(B) with dpic, A-(B.x,B.y) with gpic
vec_(x,y)	gen	position rotated with respect to current direction
View3D	3D	The view vector (triple) defined by <code>setview(azim, elev)</code> . The <code>project</code> macro projects onto the plane perpendicular to this vector
vlength(x,y)	gen	vector length $\sqrt{x^2 + y^2}$
vperp(linear object)	gen	unit-vector pair CCW-perpendicular to linear object
Vperp(position name, position name)	gen	unit-vector pair CCW-perpendicular to line joining two named positions
vrot_(x,y,xcosine,ycosine)	gen	rotation operator
vscal_(number,x,y)	gen	vector scale operator
Vsprod_(position, expression)	gen	The vector in arg 1 multiplied by the scalar in arg 2
Vsum_(position,position)	gen	Vsum_(A,B) evaluates to A+B with dpic, A+(B.x,B.y) with gpic
W w_	gen	.w with respect to current direction
while_('test','actions')	gen	Integer m4 while loop
wid_	gen	width with respect to current direction
winding(L R, diam, pitch, turns, core wid, core color)	cct	core winding drawn in the current direction; R=right-handed (Section 6)
XOR_gate(n,N)	log	'xor' gate, 2 or n inputs; N=negated input. Otherwise, arg1 can be a sequence of letters P N to define normal or negated inputs. (Section 9)
XOR_off	log	XOR and NXOR offset of input face
X xtal(linespec,keys)	cct	Quartz crystal. The keys are <code>type=N</code> (default) or <code>R</code> (round); type N keys: <code>lgth=expr</code> (body length); <code>width=expr</code> (body width); <code>bxwd=expr</code> (body inner box width); <code>box=</code> box attributes (<code>shaded ...</code>); type R keys: <code>outerdiam=expr</code> ; <code>innerdiam=expr</code> ; <code>outer=</code> outer circle attributes (<code>dotted ...</code>); <code>inner=</code> inner circle attributes (<code>shaded ...</code>) (Section 4.2)
xtract(string, substr1, substr2, ...)	gen	returns substrings if present
Y Ysymbol(at position,keys, U D L R degrees) (default U for up)	cct	Y symbol for power-system diagrams <code>keys: size=expression; type=G</code>

References

- [1] J. D. Aplevich. Drawing with dpic, 2015. In the dpic source distribution.
- [2] J. Bentley. *More Programming Pearls*. Addison-Wesley, Reading, Massachusetts, 1988.
- [3] D. Girou. Présentation de PSTricks. *Cahiers GUTenberg*, 16, 1994. http://cahiers.gutenberg.eu.org/cg-bin/article/CG_1994___16_21_0.pdf.
- [4] M. Goossens, S. Rahtz, and F. Mittelbach. *The L^AT_EX Graphics Companion*. Addison-Wesley, Reading, Massachusetts, 1997.
- [5] J. D. Hobby. A user’s manual for MetaPost, 1990.
- [6] IEC. International standard database snapshot 2007-01, graphical symbols for diagrams, 2007. IEC-60617.
- [7] IEEE. Graphic symbols for electrical and electronic diagrams, 1975. Std 315-1975, 315A-1986, reaffirmed 1993.
- [8] B. W. Kernighan. PIC—A graphics language for typesetting, user manual. Technical Report 116, AT&T Bell Laboratories, 1991. <http://doc.cat-v.org/unix/v10/10thEdMan/pic.pdf>.
- [9] B. W. Kernighan and D. M. Richie. The M4 macro processor. Technical report, Bell Laboratories, 1977.
- [10] Thomas K. Landauer. *The Trouble with Computers*. MIT Press, Cambridge, 1995.
- [11] W. Lemberg. Gpic man page, 2005. <http://www.manpagez.com/man/1/groff/>.
- [12] O. Mas. *Pycirkuit 0.5.0*. Python Software Foundation, 2019. <https://pypi.org/project/pycirkuit/>.
- [13] E. S. Raymond. Making pictures with GNU PIC, 1995. In GNU groff source distribution, also in the dpic package and at <http://www.kohala.com/start/troff/gpic.raymond.ps>.
- [14] T. Rokicki. DVIPS: A T_EX driver. Technical report, Stanford, 1994.
- [15] R. Seindal *et al*. GNU m4, 1994. <http://www.gnu.org/software/m4/manual/m4.html>.
- [16] T. Tantau. Tikz & pgf, 2013. <http://mirrors.ctan.org/graphics/pgf/base/doc/pgfmanual.pdf>.
- [17] T. Van Zandt. PSTricks: Postscript macros for generic tex, 2007. <http://mirrors.ctan.org/graphics/pstricks/base/doc/pst-user.pdf>.